

10pre™

User Guide

MOTU®

1280 Massachusetts Avenue
Cambridge, MA 02138
Business voice: (617) 576-2760
Business fax: (617) 576-3609
Web site: www.motu.com
Tech support: www.motu.com/support

SAFETY PRECAUTIONS AND ELECTRICAL REQUIREMENTS FOR THE 10pre (“PRODUCT”)

 **CAUTION! READ THIS SAFETY GUIDE BEFORE YOU BEGIN INSTALLATION OR OPERATION. FAILURE TO COMPLY WITH SAFETY INSTRUCTIONS COULD RESULT IN BODILY INJURY OR EQUIPMENT DAMAGE.**

 **HAZARDOUS VOLTAGES: CONTACT MAY CAUSE ELECTRIC SHOCK OR BURN. TURN OFF UNIT BEFORE SERVICING.**

WARNING: TO REDUCE THE RISK OF FIRE OR ELECTRICAL SHOCK, DO NOT EXPOSE THIS APPLIANCE TO RAIN OR OTHER MOISTURE.

CAUTION: TO REDUCE THE RISK OF ELECTRICAL SHOCK, DO NOT REMOVE COVER. NO USER-SERVICEABLE PARTS INSIDE. REFER SERVICING TO QUALIFIED SERVICE PERSONNEL.

WARNING: THIS EQUIPMENT IS NOT SUITABLE FOR USE IN LOCATIONS WHERE CHILDREN ARE LIKELY TO BE PRESENT.

WARNING: DO NOT PERMIT FINGERS TO TOUCH THE TERMINALS OF PLUGS WHEN INSTALLING OR REMOVING THE PLUG TO OR FROM THE OUTLET.

WARNING: IF NOT PROPERLY GROUNDED THE MOTU PRODUCT COULD CAUSE AN ELECTRICAL SHOCK.

The MOTU product is equipped with a three-conductor cord and grounding type plug which has a grounding prong, approved by Underwriters' Laboratories and the Canadian Standards Association. This plug requires a mating three-conductor grounded type outlet as shown in Figure A below. If the outlet you are planning to use for the MOTU product is of the two-prong type, DO NOT REMOVE OR ALTER THE GROUNDING PRONG IN ANY MANNER. Use an adapter as shown below and always connect the grounding lug to a known ground. It is recommended that you have a qualified electrician replace the TWO prong outlet with a properly grounded THREE prong outlet. An adapter as illustrated below in Figure B is available for connecting plugs to two-prong receptacles. In the EU, use the supplied EU power cord and be sure that the power outlet is properly grounded (Figure C).

Figure A

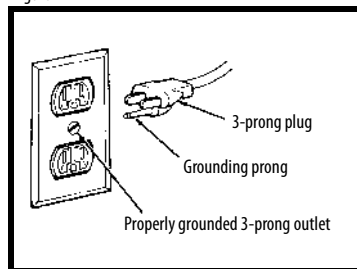

Figure B

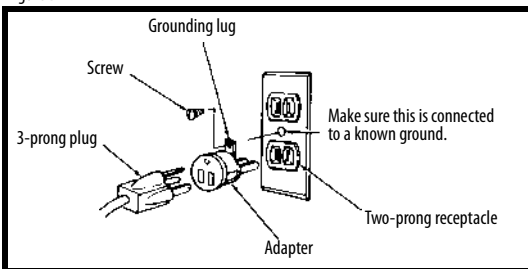
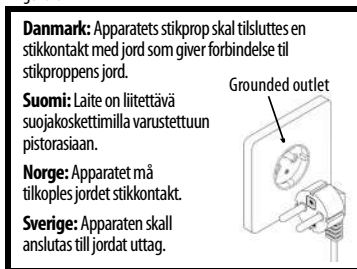

Figure C



WARNING: THE GREEN GROUNDING LUG EXTENDING FROM THE ADAPTER MUST BE CONNECTED TO A PERMANENT GROUND SUCH AS TO A PROPERLY GROUNDED OUTLET BOX. NOT ALL OUTLET BOXES ARE PROPERLY GROUNDED.

If you are not sure that your outlet box is properly grounded, have it checked by a qualified electrician. NOTE: The adapter illustrated is for use only if you already have a properly grounded two-prong receptacle. Adapter is not allowed in Canada by the Canadian Electrical Code. Use only three wire extension cords which have three-prong grounding type plugs and three-prong receptacles which will accept the MOTU product plug.

IMPORTANT SAFEGUARDS

1. Read these instructions. All the safety and operating instructions should be read before operating the product.
2. Keep these instructions. These safety instructions and the product owner's manual should be retained for future reference.
3. Heed all warnings. All warnings on the product and in the owner's manual should be adhered to.
4. Follow all Instructions. All operating and use instructions should be followed.
5. Do not use the product near water.
6. Cleaning - Unplug the product from the computer and clean only with a dry cloth. Do not use liquid or aerosol cleaners.
7. Ventilation - Do not block any ventilation openings. Install in accordance with the manufacturer's instructions.
8. Heat - Do not install the product near any heat sources such as radiators, heat registers, stoves, or another apparatus (including an amplifier) that produces heat.
9. Overloading - Do not overload wall outlets and extension cords as this can result in a risk of fire or electrical shock.
10. Grounding - Do not defeat the safety purpose of the polarized or grounding-type plug. A polarized plug has two blades with one wider than the other. A grounding-type plug has two blades and a third grounding prong. The wide blade or the third prong are provided for your safety. If the provided plug does not fit into your outlet, consult an electrician for replacement of the obsolete outlet.
11. Power cord - Protect the product power cord from being walked on or pinched by items placed upon or against them. Pay particular attention to cords and plugs, convenience receptacles, and the point where they exit from the unit.
12. Power button - Install the product so that the power button can be accessed and operated at all times.
13. Disconnect - The main plug is considered to be the disconnect device for the product and shall remain readily operable.
14. Accessories - Only use attachments/accessories specified by the manufacturer.
15. Placement - Use only with the cart, stand, tripod, bracket or table specified by the manufacturer, or sold with the product. When a cart is used, use caution when moving the cart/apparatus combination to avoid injury from tip-over.
16. Surge protection - Unplug the product during lightning storms or when unused for long periods of time.
17. Servicing - Refer all servicing to qualified service personnel. Servicing is required when the product has been damaged in any way, such as when a power-supply cord or plug is damaged, liquid has been spilled or objects have fallen into the product, the product has been exposed to rain or moisture, does not operate normally, or has been dropped.
18. Power Sources - Refer to the manufacturer's operating instructions for power requirements. Be advised that different operating voltages may require the use of a different line cord and/or attachment plug.
19. Installation - Do not install the product in an unventilated rack, or directly above heat-producing equipment such as power amplifiers. Observe the maximum ambient operating temperature listed below.
20. Power amplifiers - Never attach audio power amplifier outputs directly to any of the unit's connectors.
21. Replacement Parts - When replacement parts are required, be sure the service technician has used replacement parts specified by the manufacturer or have the same characteristics as the original part. Unauthorized substitutions may result in fire, electric shock or other hazards.
22. Safety Check - Upon completion of any service or repairs to this MOTU product, ask the service technician to perform safety checks to determine that the product is in safe operating conditions.

ENVIRONMENT, HEAT AND VENTILATION

Operating Temperature: 10°C to 40°C (50°F to 104°F). The product should be situated away from heat sources or other equipment that produces heat. When installing the product in a rack or any other location, be sure there is adequate space around the product to ensure proper ventilation. Improper ventilation will cause overheating and can damage the unit.

TO REDUCE THE RISK OF ELECTRICAL SHOCK OR FIRE

Do not handle the power cord with wet hands. Do not pull on the power cord when disconnecting it from an AC wall outlet. Grasp it by the plug. Do not expose this apparatus to rain or moisture. Do not place objects containing liquids on it.

AC INPUT

100 - 240VAC ~ - 50 / 60Hz • 1.0A max



About the Mark of the Unicorn License Agreement and Limited Warranty on Software

TO PERSONS WHO PURCHASE OR USE THIS PRODUCT: carefully read all the terms and conditions of the “click-wrap” license agreement presented to you when you install the software. Using the software or this documentation indicates your acceptance of the terms and conditions of that license agreement.

Mark of the Unicorn, Inc. (“MOTU”) owns both this program and its documentation. Both the program and the documentation are protected under applicable copyright, trademark, and trade-secret laws. Your right to use the program and the documentation are limited to the terms and conditions described in the license agreement.

REMINDER OF THE TERMS OF YOUR LICENSE

This summary is not your license agreement, just a reminder of its terms. The actual license can be read and printed by running the installation program for the software. That license agreement is a contract, and clicking “Accept” binds you and MOTU to all its terms and conditions. In the event anything contained in this summary is incomplete or in conflict with the actual click-wrap license agreement, the terms of the click-wrap agreement prevail.

YOU MAY: (a) use the enclosed program on a single computer; (b) physically transfer the program from one computer to another provided that the program is used on only one computer at a time and that you remove any copies of the program from the computer from which the program is being transferred; (c) make copies of the program solely for backup purposes. You must reproduce and include the copyright notice on a label on any backup copy.

YOU MAY NOT: (a) distribute copies of the program or the documentation to others; (b) rent, lease or grant sublicenses or other rights to the program; (c) provide use of the program in a computer service business, network, time-sharing, multiple CPU or multiple user arrangement without the prior written consent of MOTU; (d) translate, adapt, reverse engineer, decompile, disassemble, or otherwise alter the program or related documentation without the prior written consent of MOTU.

THIS LIMITED WARRANTY AND RIGHT OF REPLACEMENT IS IN LIEU OF, AND YOU HEREBY WAIVE, ANY AND ALL OTHER WARRANTIES, BOTH EXPRESS AND IMPLIED, INCLUDING BUT NOT LIMITED TO WARRANTIES OF MERCHANTABILITY AND FITNESS FOR A PARTICULAR PURPOSE. THE LIABILITY OF MOTU PURSUANT TO THIS LIMITED WARRANTY SHALL BE LIMITED TO THE REPLACEMENT OF THE DEFECTIVE DISK(S), AND IN NO EVENT SHALL MOTU OR ITS SUPPLIERS, LICENSORS, OR AFFILIATES BE LIABLE FOR INCIDENTAL OR CONSEQUENTIAL DAMAGES, INCLUDING BUT NOT LIMITED TO LOSS OF USE, LOSS OF PROFITS, LOSS OF DATA OR DATA BEING RENDERED INACCURATE, OR LOSSES SUSTAINED BY THIRD PARTIES EVEN IF MOTU HAS BEEN ADVISED OF THE POSSIBILITY OF SUCH DAMAGES. THIS WARRANTY GIVES YOU SPECIFIC LEGAL RIGHTS WHICH MAY VARY FROM STATE TO STATE. SOME STATES DO NOT ALLOW THE LIMITATION OR EXCLUSION OF LIABILITY FOR CONSEQUENTIAL DAMAGES, SO THE ABOVE LIMITATION MAY NOT APPLY TO YOU.

UPDATE POLICY

In order to be eligible to obtain updates of the program, you must complete and return the attached Mark of the Unicorn Purchaser Registration Card to MOTU.

COPYRIGHT NOTICE

Copyright © 2025 by Mark of the Unicorn, Inc. All rights reserved. No part of this publication may be reproduced, transmitted, transcribed, stored in a retrieval system, or translated into any human or computer language, in any form or by any means whatsoever, without express written permission of Mark of the Unicorn, Inc., 1280 Massachusetts Avenue, Cambridge, MA, 02138, U.S.A.

Limited Warranty on Hardware

Mark of the Unicorn, Inc. (“MOTU”) warrants this equipment against defects in materials and workmanship under normal use for a period of TWO (2) YEARS from the date of original retail purchase. The Warranty Term begins on the date of purchase from an authorized MOTU reseller and applies solely to the original retail purchaser, who must activate the warranty by creating a user account at motu.com to register the product within 90 days of purchase. This warranty applies only to hardware products; MOTU software is licensed and warranted pursuant to separate written statements.

If you discover a defect, first contact MOTU technical support by phone, email or web (motu.com/support) to verify the warranty on your MOTU equipment and obtain a Return Merchandise Authorization (RMA). No service will be performed on any product returned without prior authorization. MOTU will, at its option, repair or replace the product at no charge to you, provided you return it during the warranty period as instructed by MOTU, with transportation charges prepaid. If you purchased your equipment in any country other than the US or Canada, you will be instructed to return the equipment to an authorized MOTU distributor or representative in the country of purchase. You must use the product’s original packing material for the shipment, and insure the shipment for the value of the product. Please include your name, address, phone number, email address, a description of the problem, and the original, dated bill of sale with the returned unit; do NOT include additional accessories such as cables, power supplies, manuals, etc. Please clearly print the Return Merchandise Authorization Number on the outside of the box below the shipping address. Repaired or replaced equipment will be returned to you via UPS Ground prepaid. (Expedited shipping methods such as UPS next day, 2-day, and 3-day services are available for an additional cost.) Repaired equipment will be warranted for a period equal to the remainder of the original Limited Warranty or for 90 days, whichever is longer.

WARRANTY EXCLUSIONS: This warranty does not apply if the equipment has been damaged by accident, abuse, misuse, or misapplication; has been modified without the written permission of MOTU; or if the product serial number has been removed or defaced. The following examples, without limitation, are NOT covered by this hardware warranty:

- Equipment purchased through any reseller not directly authorized by MOTU or its authorized international distributors.
- “Used” equipment purchased from a third party.
- Equipment purchased in another country.
- Normal cosmetic and mechanical wear of the equipment.
- Equipment damaged by improper installation or connections.
- Equipment damaged in transit to/from MOTU for warranty repair.
- Physically damaged equipment, including but not limited to water damage, cracks or dents, missing or bent parts, burns or other damage caused by faulty or failed electric power

ALL IMPLIED WARRANTIES, INCLUDING IMPLIED WARRANTIES OF MERCHANTABILITY AND FITNESS FOR A PARTICULAR PURPOSE, ARE LIMITED IN DURATION TO TWO (2) YEARS FROM THE DATE OF THE ORIGINAL RETAIL PURCHASE OF THIS PRODUCT. THE WARRANTY AND REMEDIES SET FORTH ABOVE ARE EXCLUSIVE AND IN LIEU OF ALL OTHERS, ORAL OR WRITTEN, EXPRESS OR IMPLIED. No MOTU dealer, agent, or employee is authorized to make any modification, extension, or addition to this warranty. MOTU IS NOT RESPONSIBLE FOR SPECIAL, INCIDENTAL, OR CONSEQUENTIAL DAMAGES RESULTING FROM ANY BREACH OF WARRANTY, OR UNDER ANY LEGAL THEORY, INCLUDING LOST PROFITS, DOWNTIME, GOODWILL, DAMAGE OR REPLACEMENT OF EQUIPMENT AND PROPERTY AND COST OF RECOVERING REPROGRAMMING, OR REPRODUCING ANY PROGRAM OR DATA STORED IN OR USED WITH MOTU PRODUCTS.

Some states do not allow the exclusion or limitation of implied warranties or liability for incidental or consequential damages, so the above limitation or exclusion may not apply to you. This warranty gives you specific legal rights, and you may have other rights which vary from state to state.

This equipment has been type tested and found to comply with the limits for a class B digital device, pursuant to Part 15 of the FCC Rules. These limits are designed to provide reasonable protection against harmful interference in a residential installation. This equipment generates, uses, and can radiate radio frequency energy and, if not installed and used in accordance with the instruction manual, may cause harmful interference to radio communications. However, there is no guarantee that interference will not occur in a particular installation. If this equipment does cause interference to radio or television equipment reception, which can be determined by turning the equipment off and on, the user is encouraged to try to correct the interference by any combination of the following measures:

- Relocate or reorient the receiving antenna
- Increase the separation between the equipment and the receiver
- Plug the equipment into an outlet on a circuit different from that to which the receiver is connected

If necessary, you can consult a dealer or experienced radio/television technician for additional assistance.

PLEASE NOTE: only equipment certified to comply with Class B (computer input/output devices, terminals, printers, etc.) should be attached to this equipment, and it must have shielded interface cables in order to comply with the Class B FCC limits on RF emissions.

WARNING: changes or modifications to this unit not expressly approved by the party responsible for compliance could void the user's authority to operate the equipment.



Contents

Part 1: Getting Started

- 7 **Quick Start Guide**
- 8 **A Typical 10pre Setup**
- 9 **10pre Front Panel**
- 10 **10pre Rear Panel**
- 11 **About the 10pre**
- 15 **Packing List and System Requirements**
- 16 **Software Installation**
- 19 **Hardware Installation**

Part 2: Using the 10pre

- 29 **Front Panel Operation**
- 37 **CueMix Pro**
- 62 **Working with Host Audio Software**
- 69 **Optical Expander Presets**
- 71 **Networking**

Part 3: Appendices

- 80 **Troubleshooting**
- 82 **Audio Specifications**
- 86 **Index**

Part 1

Getting Started

Quick Start Guide

Thank you for purchasing an 10pre! Follow these easy steps to get started quickly.

MAC USERS START HERE

- 1 Visit motu.com/10pre-start to download the *MOTU Pro Audio v2.dmg* virtual disk image.
- 2 Copy the CueMix Pro app to your Applications folder. If you are running macOS 13 or later, launch CueMix Pro and click *Install* in the *Discovery* tab. Visit *System Settings* > *Privacy & Security* to allow the driver to install.
- 3 Connect the included power cord to the 10pre, and connect the 10pre to your Mac using the included USB-C cable. If your Mac requires it, use a USB-IF certified USB-C-to-A cable. Plug adapters are not recommended. See page 19.
- 4 Choose *Apple menu* > *System Settings* (or *System Preferences*) and click *Sound* to choose the 10pre as the input and output device.
- 5 Proceed to “For all users”.

WINDOWS USERS START HERE

- 1 BEFORE you connect the 10pre to your computer, visit motu.com/10pre-start to download and run *MOTU Pro Audio v2* installer.
- 2 Connect the included power cord to the 10pre.
- 3 Connect the 10pre to your computer using the included USB-C cable. If your computer requires it, use a USB-IF certified USB-C-to-A cable. Plug adapters are not recommended. See page 19.
- 4 Go to the Start menu, choose *Sound Settings*, and choose 10pre as the default recording and playback device.
- 5 Proceed to “For all users”.

FOR ALL USERS

6 As shown on the next page, connect speakers to the 10pre *Line Out 1-2*, or connect a pair of headphones to either headphone output on the front panel, so you can hear your computer’s audio output.

7 You are now ready to start using your 10pre interface.

8 Visit motu.com/10pre-start to register your 10pre, download the included software and watch brief how-to videos, including:

- How to connect other gear to the 10pre.
 - How to use the 10pre with your recording software.
 - How to get the most out of the 10pre.
- 👉 Register your 10pre to gain access to all the software, virtual instruments, loops and sounds that are included with your 10pre purchase. Registered users also qualify for technical support and information about software updates, so please register today!

RACK-MOUNT INSTALLATION

The 10pre can be mounted in a standard 19-inch (48.26 cm) equipment rack using four standard 10-32 5/8th-inch or M6 1mm pan head rack screws. It is one rack unit (1U) high (1.75 inches, 44.45 mm) with a depth of 12.25 inches (31 cm).

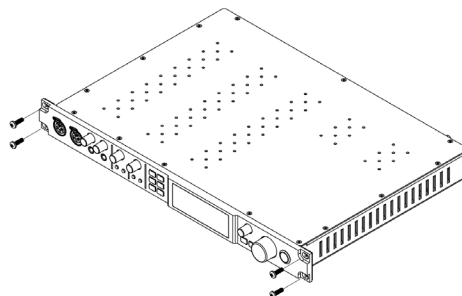

A Typical 10pre Setup

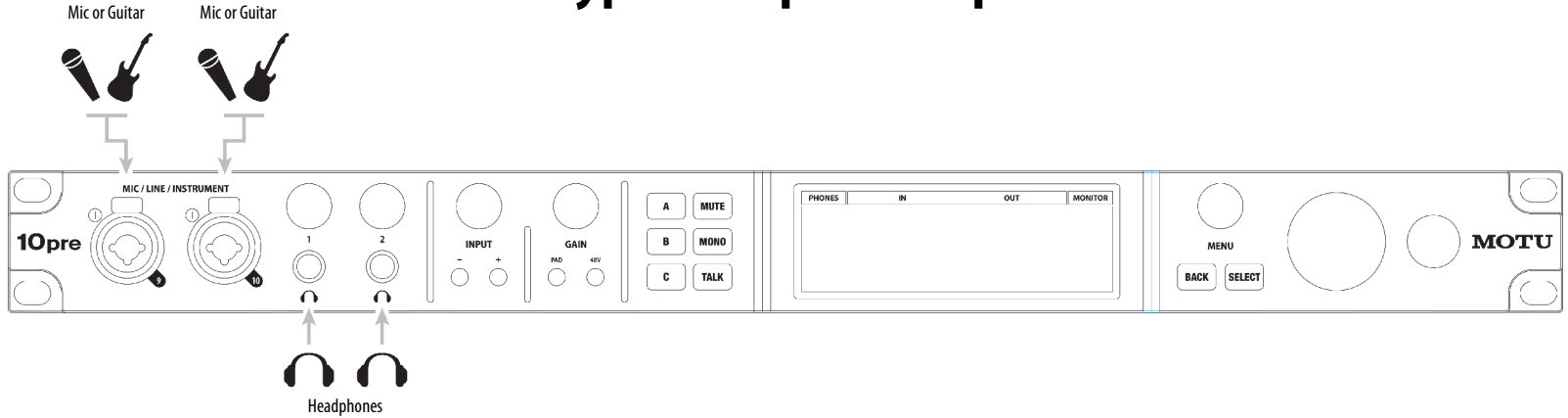

NOTE: Speakers and monitors must be self-powered

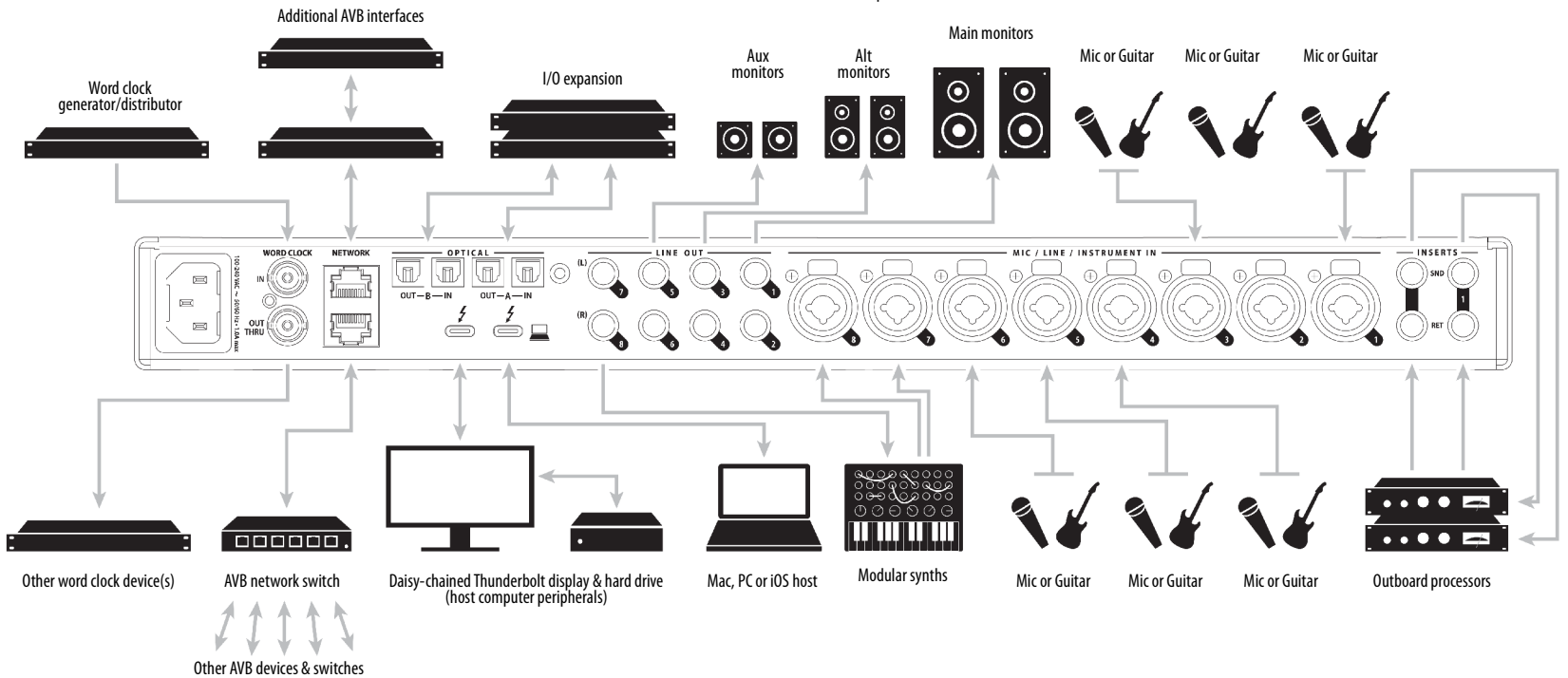

10pre Rear Panel

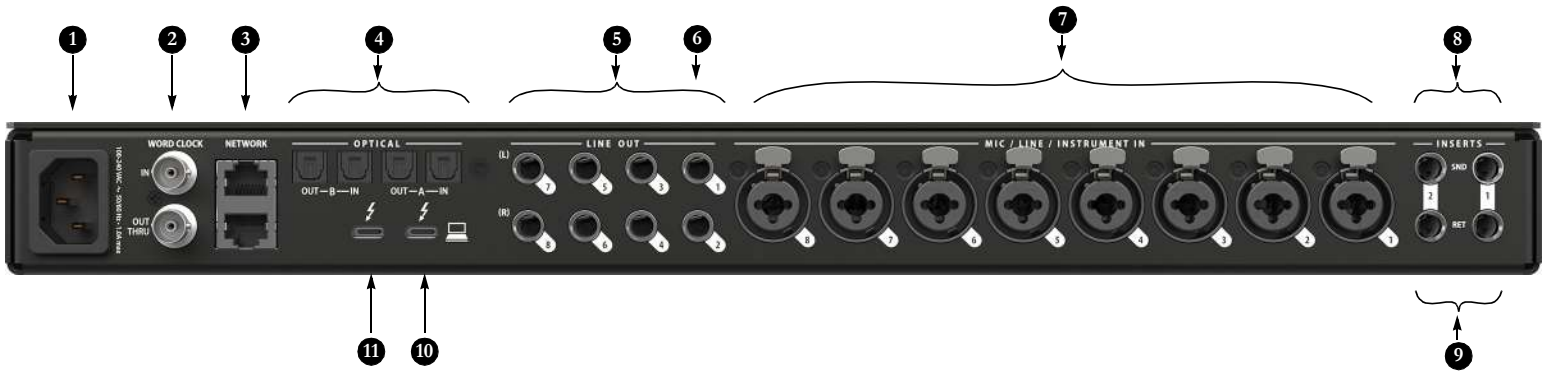

1. The 10pre is equipped with a universal international power supply (100-240 VAC, 50/60 Hz, 1.0A max) with a standard IEC connector.
2. These are standard BNC WORD CLOCK jacks. Use them for a variety of applications, such as digital I/O with devices that cannot resolve to the clock supplied by their digital I/O connection with the 10pre. See “Syncing word clock devices” on page 26.
3. These two NETWORK ports provide industry standard IEEE 802.1 (AVB) network connectivity to other network devices. Examples include:
 - Another 10pre or any other MOTU AVB-equipped audio interface, such as the 16A (2025), 1248, 8M, 16A (original), 24Ai, 24Ao, 112D, Monitor 8, etc.
 - A standard Ethernet hub or Wi-Fi router (for internet connection).
 - A standard AVB Ethernet switch for high-speed, low latency, high-capacity audio connectivity to an AVB audio network.

For details see chapter 9, “Networking” (page 71).

4. These two banks of ADAT optical “lightpipe” connectors each provide 8 channels of 24-bit ADAT optical digital I/O at 1x sample rates (44.1 or 48 kHz) and 4 channels at 2x sample rates (88.2 or 96 kHz). They are disabled at higher sample rates. Bank A can alternately operate as stereo TOSLink (optical S/PDIF) connectors. See “Optical I/O” on page 25 and “Syncing optical devices” on page 26.

Note: you can choose independent formats for Bank A IN and OUT. For example, you could choose ADAT for the optical A IN (for eight channels of input from your digital mixer, for example) and stereo TOSLink for the optical A OUT (for a set of auxiliary speakers, for example).

5. The eight LINE OUT jacks are balanced, DC-coupled quarter-inch connectors that can also accept a TRS plug with the ring disconnected for unbalanced operation (see “TRS quarter-inch line outputs” on page 23 for more on this). They provide analog output for studio monitors, surround monitoring, sub-mixes or any other desired destination. The output trim can be adjusted from the Outputs Tab in the CueMix Pro app. For surround monitoring, connect your surround speakers to outputs and see “The Monitor Group” on page 32.

6. From the factory, Line Outs 1-2 serve as the 10pre main output pair for primary (powered) studio monitors, PA speakers or any other desired destination. You can control their volume from the front panel MONITOR knob (#11 on page 9).

To hear audio playback from your host audio software on this pair of outputs, assign audio tracks (and master fader) to Line Out 1-2. You can also use the CueMix Pro app to route live 10pre inputs here as well.

7. These eight XLR/TRS combo jacks accept a mic cable or a quarter-inch cable, balanced or unbalanced, from a guitar or line level source. Use the front panel controls (item #3 on page 9) to adjust individual preamp gain, 48V phantom power and optional -20 dB pad for each mic input.
8. These two balanced quarter-inch SEND jacks supply the pre-amplified input signal from mic/line/instrument inputs 1 and 2 (7). Use them to insert your favorite compressor, EQ, reverb or other outboard effect. Use the corresponding return jack below to return the signal to the Input 1 or 2 signal path.
9. These two balanced quarter-inch RETURN jacks re-insert the signal back into the corresponding Input 1 or 2 signal path. If nothing is plugged in to the corresponding mic

input, this return acts as a line input. When nothing is connected to these returns, they are automatically “normaled” to the send to receive signal directly from the preamp.

10. Use this (upstream) HOST port to connect the 10pre to a computer or iOS device using the included USB-C cable. The 10pre negotiates the best-possible connection to the host (Thunderbolt, USB4, USB3 or USB2). For details, see chapter 4, “Hardware Installation” (page 19).
11. Use this (downstream) DEVICE port to connect computer peripherals such as hard drives, monitors, additional 10pre’s, a USB hub or Thunderbolt dock, etc. Essentially, you can connect any device here that you could connect directly to your computer. If your computer supports Thunderbolt, you can daisy-chain multiple Thunderbolt devices to this port.

CHAPTER 1 About the 10pre

The 10pre is a 26 x 28 Thunderbolt/USB audio interface with mixing, DSP effects, AVB networking, and very high quality A/D/A conversion at sample rates up to 192 kHz.

Hardware-driven DSP delivers a powerful 64 channel monitor mixer with 16 stereo buses, 32-bit floating point effects processing, double-precision 4-band EQ, compression, gating, HPF, and reverb.

A comprehensive patch bay provides flexible routing between the mixer, local I/O and the AVB network.

The 10pre can operate as an audio interface for a computer or iOS device, as a stand-alone digital mixer, as a gateway to an expanded studio system, as a component of an extended AVB audio network, or as a capable hybrid device performing all of these roles simultaneously.

The 10pre is designed to be a central component of a modern, high performance recording studio or live mixing platform. The following sections provide a brief overview of its main features and characteristics.

Comprehensive I/O

The 10pre provides 54 channels of simultaneous input and output.

Connection	Input	Output
Mic/guitar inputs on combo XLR/TRS	10	-
Quarter-inch analog on bal/unbal TRS	-	8
Headphone output	-	2 x stereo
ADAT optical digital (at 44.1 or 48 kHz)†	16	16
Total	26	28

† The 10pre optical connectors support the industry-standard ADAT and TOSLink optical I/O formats, which provide varying channel counts. TOSLink is available on Bank A, and ADAT is available on both banks (A and B). See “Optical I/O” on page 25 for details about optical bank operation.

Universal connectivity

The 10pre connects to a host computer via Thunderbolt or USB, depending on the host. The 10pre negotiates the best-possible connection to the host (Thunderbolt, USB4, USB3 or USB2). It is USB audio class-compliant, which means that it is iOS compatible and does not require driver installation for USB connection to macOS or iOS hosts. Industry standard audio drivers for both Thunderbolt and USB operation provide universal compatibility with any audio software.

Up to 256 channels of audio I/O

The 10pre lets you stream up to 128 audio channels in and out, simultaneously, through its Thunderbolt connection to a host computer. Sources and destinations can include inputs and outputs on the device, inputs and outputs on other interfaces connected via AVB networking, and even audio software apps running on other computers connected to other devices on the network.

State-of-the-art A/D and D/A conversion

The analog section of each interface employs state-of-the-art 32-bit DACs and ADCs, which deliver analog recording and playback with remarkably high dynamic range at sample rates from 44.1 to 192 kHz.

Mic/guitar inputs with preamps

The ten mic/line/instrument inputs (eight on the rear panel and two on the front) are equipped with preamps and “combo” XLR/TRS jacks, which accept XLR microphone inputs or quarter-inch line/instruments inputs. Individual 48 volt phantom power and a -20 dB pad can be applied independently to each mic input. The Precision Digital Gain™ knob on the front panel provides up to 74 dB of gain in precise 1 dB increments.

Mic/guitar inserts

Before A/D conversion, the pre-amplified signal from mic/guitar inputs 1 and 2 are routed to one of the two quarter-inch analog sends, so that you can insert a favorite outboard EQ, compressor, amp or effects processor to the mic/guitar input signal before it is converted to digital form. The resulting output from the outboard gear can be fed back into the 10pre via the corresponding return jack for the channel, for routing to the computer and/or inclusion in the 10pre built-in monitor mixes. If nothing is plugged in to the input jack, the return jack can serve as an additional line input, identical to the other eight analog inputs.

Flexible analog I/O with Precision Digital Gain & Trim™

Equipped with renowned ESS Sabre32™ DAC technology, all analog outputs offer trim (cut), also adjustable in 1 dB increments. Outputs can be trimmed down to -99 dB.

All quarter-inch outputs are DC-coupled, so they can be used for control voltage (CV) output.

On-board DSP with mixing and processing

The 10pre is equipped with a DSP engine that drives a 64-input monitor mixer with 32 buses. The mixer offers familiar operation modeled after large format mixing consoles. Effects include 4-band parametric EQ, compression, gating, high-

pass filter, and reverb. The included CueMix Pro app provides easy and intuitive on-screen control of everything from your computer or iOS device.

32-bit processing

The DSP engine delivers 32-bit floating point processing for virtually infinite headroom, with 64-bit double-precision processing for the EQ filters for the utmost in sonic quality.

Software control

Control the 10pre on-board mixing and device settings from the CueMix Pro app software running on a laptop or iOS device.

Stand-alone mixing

Control all 10pre settings on the road at rehearsals or gigs — great for live sound mixing — from your iOS device, connected directly with USB cable or connected wirelessly over the local Wi-Fi network.

ADAT digital I/O

The 10pre provides two 8-channel banks of optical digital I/O. Connect outboard digital processors, digital mixers or other gear: 16 channels at 44.1/48 kHz or 8 channels at 88.2/96 kHz. Alternately, the optical Bank A ports can be independently configured to support stereo TOSLink (optical S/PDIF).

Bank A input and output operate independently, allowing you to mix and match optical formats. For example, you could receive four channels of 96 kHz S/MUX input while at the same time sending 96 kHz stereo optical S/PDIF (“TOSLink”) to the output.

Network I/O

AVB stands for *Audio Video Bridging*, a collection of IEEE standards to enable high-bandwidth, low-latency audio streaming over Ethernet. The 10pre’s two network ports support 128 channels of network audio input and output for an additional

256 simultaneous audio channels (at 1x or 2x samples rates) using standard CAT-5e or CAT-6 Ethernet cables with lengths up to 100 meters.

Multiple 10pre's or other AVB devices can be daisy-chained up to seven "hops" (links in the chain). Connectivity to a wider network can be achieved with standard AVB Ethernet switches connected to other MOTU AVB devices, 3rd-party AVB devices, and multiple computers, each with full access to all devices on the network (including the other computers).

The entire network operates with near-zero network latency, even over very long cable runs. MOTU's AVB implementation allows you to stream hundreds of audio channels among devices and computers on the network with guaranteed Quality of Service (QoS), prioritizing audio streams over less important network traffic.

Matrix routing and multing

The 10pre provides completely flexible matrix-style audio routing and multing. You can route any analog or digital input, computer channel, or network stream to any other output, computer, or network device. You can also mult any single input to unlimited multiple output destinations.

Word clock

The 10pre supports standard word clock synchronization at any supported sample rate. The word clock OUT port can alternately be used as a THRU port for placing the 10pre in a properly-terminated word clock daisy-chain.

Full-color LCD display

The 3.9-inch full-color 24-bit RGB IPS TFT LCD display has 480 x 128 pixel resolution and shows all signal activity at a glance with precise, detailed metering for all I/O. You can access many hardware settings directly from the front panel.

Two flexible, independent headphone outputs

The 10pre front panel provides two independent headphone jacks with separate volume control. You can program each phone output with its own independent mix, or any available source from the 10pre's extensive routing matrix.

Control room features

Control room features include talkback and A/B/C monitor select, mute and sum-to-mono for the main outs, all available from controls on the front panel or in the CueMix Pro app. Surround monitoring control is also supported for common formats such as 5.1, 7.1, and others (up to eight channels).

Rack mount or desktop operation

The 10pre is housed in a rugged steel full-rack enclosure.

CueMix Pro app

You can control on-board DSP, mixing, device settings, clock/sync settings, and network audio routing from the CueMix Pro app software for macOS, Windows, and iOS. Run CueMix Pro on a tablet or smart phone and control the 10pre wirelessly through your local Wi-Fi network. Multiple devices can be used simultaneously to access any audio interface settings on the network.

Stand-alone mixing with wireless control

If you connect your MOTU interface to a Wi-Fi router with a standard Ethernet cable, you can control its powerful mixing and DSP effects from your smart phone or tablet, without a computer — great for live sound mixing from your iPad, tablet, or other wireless device.

Performer Lite

Performer Lite is a full-featured audio workstation software package for Mac and Windows that is available as a free download for you as an 10pre owner. Visit motu.com/download to obtain your copy. Performer Lite provides multi-track MIDI

and audio production, over 100 included virtual instruments, automated virtual mixing, graphic editing, music notation editing, real-time effects plug-ins with crossfades, support for many third-party audio plug-ins, sample-accurate editing and placement of audio, and more.

CHAPTER 2 **Packing List and System Requirements**

PACKING LIST

The 10pre ships with the items listed below. If any of these items are not present in the box when you first open it, please immediately contact your dealer or MOTU.

- 10pre audio interface
- 40 Gbps/240W USB-C cable
- IEC power cord
- Printed user guide
- Getting Started card

SYSTEM REQUIREMENTS

- Intel Core i3 Mac or PC (or AMD equivalent). Faster CPUs, including Apple silicon, are recommended for best performance.
- 4GB RAM; 8 GB or more recommended.
- Windows 11 23H2 or later.
- macOS 12 or later. For best possible performance, macOS 13 or later is recommended. See “MacOS compatibility” below for details.
- iOS device running iOS 17 or higher
- Available Thunderbolt, USB4, USB3 or USB2 port.
 - 🔌 A Thunderbolt 3 port (or higher) is required for Thunderbolt operation.
- A large hard drive (preferably at least 512 GB).

MACOS COMPATIBILITY

The 10pre employs Apple’s latest macOS driver model, which requires macOS 13 or later. Once you run the 10pre driver installer on these systems (from the CueMix Pro App *Discovery* tab), the

10pre can connect to the host computer via Thunderbolt (128 channels) or USB4 (128 channels) for best possible latency performance.

Using the 10pre on macOS 12

The 10pre supports USB audio class-compliant operation on macOS 12. Simply connect the 10pre to the computer and it will operate as either a USB2 interface (64 channels) or USB3 interface (64 channels), depending on the host computer. Latency performance will be almost as good as Thunderbolt. The CueMix Pro app can be copied to your Applications folder and used as normal. An additional installer package is included on the software installer disk image specifically for macOS 12 (recommended).

iOS COMPATIBILITY

The 10pre and the CueMix Pro app require an iOS device running iOS 17 or higher. You can use the 10pre as an audio interface with your iPhone or iPad using USB class compliant operation. If you have an iPad with an Apple silicon (M series) processor, you can enable the 10pre’s low-latency Thunderbolt/USB driver for best possible performance. See “Software installation for iOS” on page 17.

PLEASE REGISTER TODAY!

Please register the 10pre today: motu.com/register.

As a registered user, you will be eligible to receive free bundled software, technical support and announcements about product enhancements as soon as they become available. Only registered users can receive the included free software, so please register today.

Thank you for taking the time to register your new MOTU products!

CHAPTER 3 Software Installation

- Software installation for macOS 16
- Software installation for Windows 17
- Software installation for iOS 17
- Audio drivers 17
- CueMix Pro app 18
- Performer Lite workstation software 18
- Working with host audio software 18

SOFTWARE INSTALLATION FOR macOS

1 Visit www.motu.com/10pre-start to download the latest macOS *MOTU Pro Audio v2.dmg* virtual disk image.

2 Open the disk image and copy the CueMix Pro app to the Applications folder.

☛ CueMix Pro must reside in the Applications folder for the driver installation process.

3 If you are running macOS 13 or later, launch CueMix Pro. If you are using an earlier macOS version, see “Operation on macOS 12” on page 17.

4 As CueMix Pro launches, macOS will ask you to allow CueMix Pro to access devices on local networks. It is very important to click *Allow* here.



Figure 3-1: Be sure to click 'Allow' in this macOS alert, so that CueMix Pro can communicate with your 10pre device.

☛ Network access is required for CueMix Pro to communicate with your 10pre device, even if it is connected to your computer with Thunderbolt or USB.

5 In CueMix Pro's *Discovery* tab, click *Install*.

6 When the new driver extension alert appears, click *Open System Settings*.



Figure 3-2: Click 'Open System Settings' in the new driver extension alert.

7 In the resulting *Driver Extensions* dialog, enable the *CueMix Pro* driver extension, as shown in Figure 3-3 (for macOS 15).

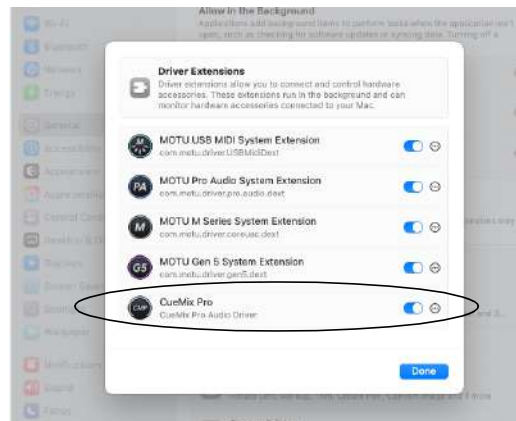

Figure 3-3: Enabling the CueMix Pro Driver Extension (in macOS 15).

Operation on macOS 12

If you are running macOS 12, driver installation (from the CueMix Pro Discovery tab) is not available. Instead, the 10pre operates as a USB audio class-compliant device that uses the macOS USB audio driver. You can use CueMix Pro to manage the settings in the interface and use all of its mixing and routing capabilities. An additional installer package is included on the software installer disk image specifically for macOS 12 (recommended).

SOFTWARE INSTALLATION FOR WINDOWS

☛ We recommend that you run the software installer *before* you connect the 10pre to your computer and power it on. This ensures that all driver components are properly installed in your system.

- 1 Visit www.motu.com/10pre-start to download the latest Windows *MOTU Pro Audio v2* installer.
- 2 Run the installer and follow the directions it gives you.

SOFTWARE INSTALLATION FOR iOS

Audio-class compliant operation allows you to connect the 10pre to any iOS device (via either USB-C or a standard Lightning camera connection kit adapter). The 10pre then provides multi-channel audio I/O to your iOS audio apps, and you can access all of its settings, features, and mixing with the CueMix Pro app, available for download from the Apple App store.

If you have an iPad with an Apple silicon (M series) processor, you can enable the 10pre's low-latency Thunderbolt/USB driver for best possible performance. Go to *Settings > Apps > CueMix Pro Audio Driver*.

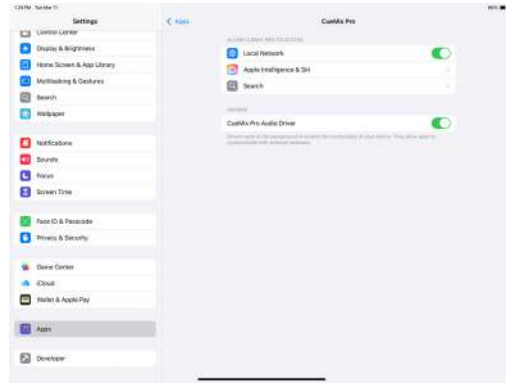

Figure 3-4: Enabling the iPadOS CueMix Pro Audio Driver for lowest possible latency iOS performance. iPads with Apple silicon (M series) processors support the 10pre Thunderbolt/USB driver.

AUDIO DRIVERS

The installer provides a Thunderbolt and USB audio driver for macOS 13 and later (CoreAudio) and Windows (ASIO and Wave).

Industry-leading I/O latency performance

On macOS and Windows, the 10pre driver provides exceptionally low I/O latency performance. For example, with a 32-sample buffer size, an 10pre interface operating at 96 kHz produces round trip latency (RTL) performance of approximately two milliseconds (ms) on macOS and Windows. RTL is the measurement of the time it takes audio to pass from an analog input, through a high-performance DAW host such as Digital Performer, to an analog output.

ASIO Driver support

On Windows, to enable the 10pre in your ASIO host software, choose the *MOTU Pro Audio v2* ASIO driver, as shown in Figure 7-1 on page 63.

WDM / Wave driver support

On Windows, the MOTU Pro Audio v2 driver includes support for WDM (Wave) compatible audio software. See item #11 on page 40.

Buffer Size

When connected to a Windows computer, the *Buffer Size* menu is available in the Device tab (item #9 on page 40). This setting determines the amount of latency (delay) you may hear when live audio is patched through your Windows audio software. Smaller buffer sizes produce lower latency, with sizes of 256 samples or less producing virtually imperceptible delay. Many host applications report audio hardware I/O latency, so you can see what happens to the reported latency when making adjustments to this setting.

Be careful with very small buffer sizes, as they can cause performance issues from your host software or PC.

☞ At sea level, audio travels approximately one foot (30 cm) per millisecond. A latency of ten milliseconds is about the same as being ten feet (three meters) from an audio source.

Output Safety Offset

When connected to a Windows host, the *Output Safety Offset* menu in the Device tab of the CueMix Pro app also becomes available (item #10 on page 40). This setting allows you to further reduce host latency. However, the lower latency setting may cause your host software to experience performance issues. Be mindful when choosing the lower latency setting, as this parameter can have a significant impact on your computer system's performance.

CUEMIX PRO APP

CueMix Pro is an easy-to-use app for macOS, Windows and iOS that gives you complete control over all the settings in your 10pre interface. For details, see chapter 6, “CueMix Pro” (page 37).

PERFORMER LITE WORKSTATION SOFTWARE

Performer Lite is an easy to use audio workstation software package for macOS and Windows that lets you record, edit, mix, process, bounce and master multi-track recording projects. Advanced features include over 100 included virtual instruments, real-time effects processing, recording, and much more.

To obtain Performer Lite, visit motu.com to register your MOTU audio interface, download Performer Lite and activate it on your computer.



Figure 3-5: Performer Lite.

WORKING WITH HOST AUDIO SOFTWARE

For further information about using the 10pre with host audio software, see chapter 7, “Working with Host Audio Software” (page 62).

CHAPTER 4 Hardware Installation

- Host computer setup 19
- iOS setup (USB-C)..... 20
- iOS setup (Lightning) 20
- Device port setup..... 21
- Connecting multiple 10pre’s to a host 21
- A typical 10pre setup 22
- Audio connections 22
- Synchronization 25
- Syncing optical devices 26
- Syncing word clock devices 26
- Syncing AVB devices..... 27

HOST COMPUTER SETUP

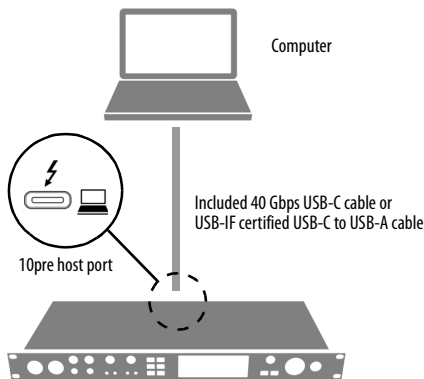

Use this setup if you want to use the 10pre as a Thunderbolt or USB audio interface for a computer.

- Use the included 40 Gbps USB-C cable.
- Connect to any USB-C port on the computer or to a USB hub or Thunderbolt dock connected to the computer.
- The 10pre negotiates the highest performance connection to the host (Thunderbolt, USB4, USB3 or USB2) based on what the host supports and the cable used for the connection. The USB-C cable



included with the 10pre supports all formats. The status section in the front panel LCD (item #15 on page 9) indicates the format of the computer connection achieved.

⚡ Thunderbolt operation requires connection to a host computer with a USB-C style Thunderbolt port. Computers with legacy displayport-style Thunderbolt 1 or 2 ports (as shown above) are not supported. *Adapters are also not supported.*

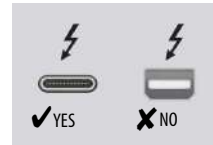

- The 10pre does not supply bus power to the host computer, so be sure the computer has its own power source.

- If your computer doesn't have a USB-C port, use a USB C-to-A cable. For best performance and reliability, a USB-IF certified cable is recommended.



- ⚡ USB-C-to-A plug adapters with a male USB-A plug and a female USB-C port (designed to accept the host-side of the C-to-C cable) *should not be used*, as they are not compliant with USB-IF standards.



This type of USB A-to-C adapter is not recommended.

- For Mac operation, no driver installation is necessary (for USB operation), but it is highly recommended for best performance. Driver Installation is required for Thunderbolt operation. For PC operation, driver installation is required. See chapter 3, “Software Installation” (page 16).

iOS SETUP (USB-C)

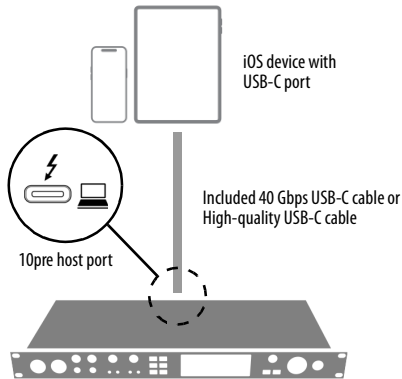

Use this setup if you want to use the 10pre as an iOS audio interface, or to control it from your iOS device.

- Use this setup for iOS devices with a USB-C port.
- Connect the 10pre directly to the iOS device with the included 40 Gbps USB-C cable or a high-quality USB-C-to-C cable.
- For iOS operation, no driver installation is necessary.

iOS SETUP (LIGHTNING)

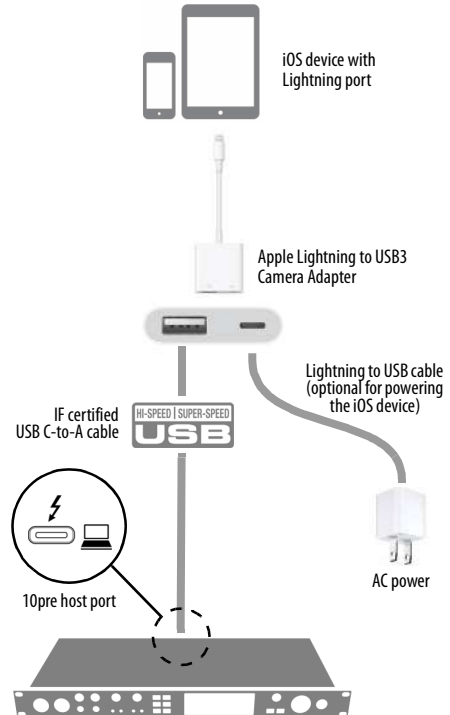

Use this setup if you want to use the 10pre as an iOS audio interface, or to control it from your iOS device.

- Use this setup for iOS devices with a Lightning port.
- For iOS devices with a Lightning port, an Apple Lightning to USB3 Camera Adapter is required (sold separately), as shown above.
- For iOS operation, no driver installation is necessary.

DEVICE PORT SETUP

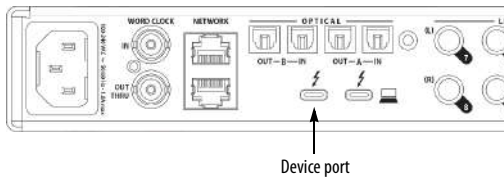

The device port allows you to connect additional computer peripheral devices, such as a hard drive or display.

Devices connected to the device port act as peripheral devices for your computer, not the 10pre itself. The 10pre serves only as a connection between the device and the computer.

What you can connect to the 10pre device port depends on the port on the computer that the 10pre is plugged into.

Think of the device port as the same as the computer port the 10pre is plugged into. If you can successfully connect a device to the computer's port, then you will be able to connect it to the 10pre's device port (when the 10pre is connected to that same computer port).

Examples of what you can connect to the device port include:

- A hard drive
- A monitor for your computer
- A USB hub
- A Thunderbolt dock

The device port supplies 15W (5V@3A) of bus power for bus-powered devices (USB or Thunderbolt).

Daisy-chained Thunderbolt devices that are bus powered share the 15W power budget supplied by the device port.

CONNECTING MULTIPLE 10PRE'S TO A HOST

To connect two or more 10pre interfaces to a host computer, use their network ports as discussed in the following sections. For further information, see chapter 9, “Networking” (page 71).

Network daisy-chain

For this approach, connect the first 10pre to the host computer (via either Thunderbolt or USB) and then daisy-chain additional units using the two AVB ports as shown below. AVB networking allows seven network “hops” (connections) in a row, which means you can connect up to eight devices in the AVB daisy-chain.

The advantage of this setup is that it can be employed with either Thunderbolt or USB, although Thunderbolt supports more audio channels to and from the host computer (128 in and 128 out). In addition, you do not need to set up an aggregate device in macOS. This setup is also recommended for PC hosts. In this scenario, the 10pre units resolve their clocks to one another via their network connections, which prevents their audio streams from drifting apart from one another over time.

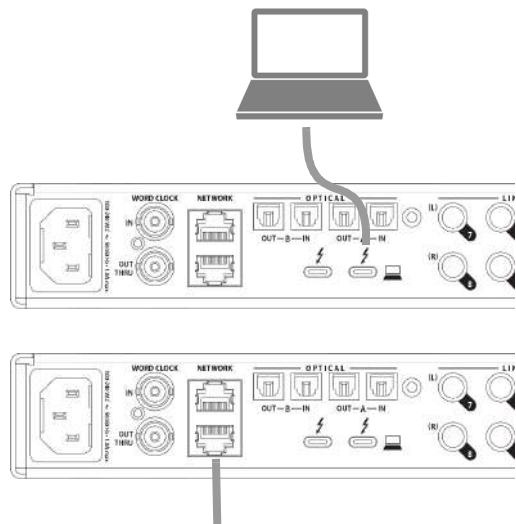

Etc. up to eight units total (seven network “hops”)

Network switch

A network switch can be used to create a star configuration of interfaces. In general AVB networking provides the most flexible and expandable method for connecting multiple 10pre interfaces to a computer (or multiple computers on the network) with long cable runs and very low latency. For further information, see chapter 9, “Networking” (page 71).

A TYPICAL 10PRE SETUP

See the diagram on page 8 for an example of typical connections to the 10pre. The following sections provide important information for achieving best results for each type of connection.

AUDIO CONNECTIONS

Here are a few things to keep in mind as you are making audio connections to your 10pre interface.

Mic/line/instrument inputs with preamps

Connect a microphone to any XLR/quarter-inch combo jack with a standard XLR mic cable. Connect a guitar or line level input with balanced or unbalanced cable with a quarter-inch plug. Adjust the level with the gain knob on the front panel for either type of input.

☛ If you need to connect a +4 dBu (line level) signal to inputs 3 or 4, use the mic inserts (see “Inserts for mic inputs 1 and 2” on page 22), which provide a signal path that matches the line inputs. If you need to use the combo jack input for some reason, be sure to engage the -20 dB pad.

48V phantom power

If you are connecting a condenser microphone or another device that requires phantom power, engage the corresponding front-panel phantom power button.

Figure 4-1: 10pre front panel



Preamp gain

The 10pre preamps provides 74 dB of gain. Use the front panel channel select and gain knob to adjust gain as needed for each input. The front-panel screen provides visual feedback as you turn the knob. Preamp gain is digitally controlled, so you can make fine-tuned adjustments in 1dB increments. You can also adjust preamp gain in the CueMix 5 app. See “Home tab” on page 39.

-20 dB pad

Each mic input (XLR jack) is equipped with a -20 dB pad button, to accommodate input signals that could overdrive the input. The pad button does not affect the quarter-inch input of the combo jack, which supports line level signals up to +20 dBu balanced and +18 dBu unbalanced.

Combo jack summary

Use these guidelines for 48V phantom power, pad and gain settings on the two combo input jacks:

Input	48V	Pad	Gain
Condenser mic	On	Off	As needed
Dynamic mic	Off	Off	As needed
Guitar	Off	n/a	As needed
-10 dBv line level via TRS*	Off	n/a	As needed
-10 dBv line level via XLR*	Off	As needed	As needed
+4 dBv line level via XLR*	Off	On	As needed
+4 dBv line level via TRS*	Off	n/a	As needed

*See the next section below for an alternative way to connect line level signals to inputs 3 and 4 using the insert returns.

Inserts for mic inputs 1 and 2

Mic inputs 1 and 2 are equipped with a send/return loop for inserting outboard gear into the input’s signal path. The SEND jack provides

the pre-amplified mic input signal (or the signal from the input's TRS jack). Connect the SEND jack to your outboard compressor or other processor, and then connect the output from the processor to the input's RETURN jack to re-insert the signal into the input's signal path.

If nothing is plugged in to the input, the RETURN jack acts as an additional line input that is identical to the other analog inputs (described below).

When nothing is connected to the returns, they are automatically “normaled” to the send to receive signal directly from the preamp.

Mic insert gain staging

The 10pre mic inputs provide 74 dB of signal gain. The first 54 dB of gain occur before the insert point, while the final 20 dB occur after. Accordingly, when a plug is inserted into the insert RETURN jack of Mic/Inst inputs 3 or 4, CueMix Pro provides two separate gain knobs, as shown below.



Figure 4-3: 54 dB of gain occurs before the insert point, while 20 dB occurs after. Together, they provide up to 74 dB of gain.

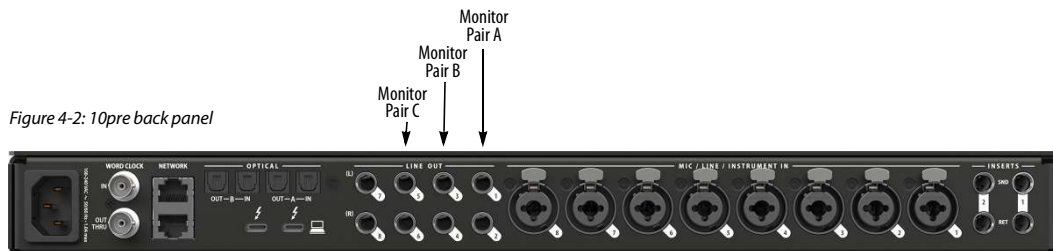

Figure 4-2: 10pre back panel

☛ The channel's 20 dB pad is applied before the insert point, while Phase Invert is applied after.

TRS quarter-inch line outputs

The quarter-inch line outputs are balanced (TRS) connectors. The outputs are DC-coupled, so they can be used for control voltage (CV) output.

☛ The line outputs are not cross-coupled. Therefore, when connecting them to an unbalanced input, use a TRS plug with the ring disconnected. Not floating the negative terminal will short it to the sleeve ground and cause distortion.

Analog I/O calibration

Various settings for the line inputs and outputs, such as gain, trim, phase invert, etc. can be accessed in the Inputs and Outputs tabs in the CueMix Pro app. See “Inputs tab” on page 41 and “Outputs tab” on page 42.

All analog inputs and outputs can be calibrated to support a variety of standards, including EBU-R68, SMPTE RP-155, +4dBu, -10dBv, 2vRMS and 1vRMS.

The line inputs are equipped with 0 to +20 dB of digital gain in 1 dB steps.

The line outputs and headphone outs are equipped with a range of digital trim from 0 to -99 dB, adjustable in 1 dB steps.

Monitor A/B/C outputs

If you have multiple sets of monitors in your studio, you can use the 10pre's A/B/C monitor switching feature to compare your mixes on each set of monitors. You can use any outputs you wish, analog or digital, for the three speaker pairs. Figure 4-2 provides an example using Line Outs 1-6. In this example, you would connect Line Outs 1-2 to your primary monitors as pair A. Then connect a secondary pair of studio monitors to Line Outs 3-4 as monitor pair B. A 3rd pair can be connected to Line Outs 5-6 as pair C. You can then use the front panel controls, or their counterparts in the CueMix Pro app (in the Outputs tab), to switch among the three monitor pairs. See "A/B/C Monitoring" on page 56.

Guitar re-amping

Re-amping allows you to record an amplified guitar signal but then change the amp tone later, after recording. This is accomplished by splitting the dry DI guitar signal during recording and separately recording the dry signal (with no amplification) on one track and the mic'd amplifier signal simultaneously on a separate track. You can then choose to use the original recorded amp tone, or you can mute that track and experiment with applying different amp tones to the dry track, either with amp (and pedal) plug-ins or by sending the output of the dry track back to your guitar amp, pedals and other tone gear.

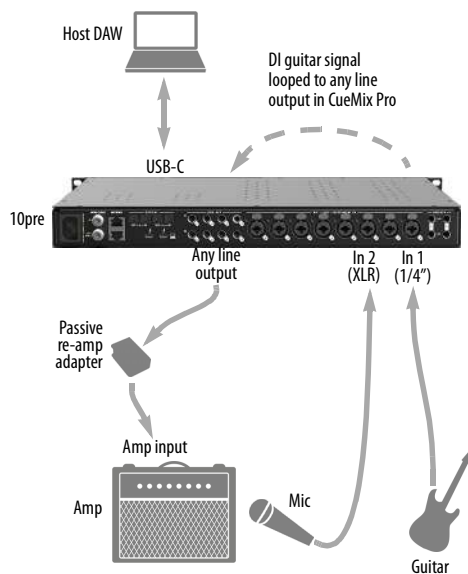

Figure 4-4: Recording guitar for re-amping.

Connections for re-amping

Figure 4-4 shows the connections needed for re-amping. Connect your guitar directly to the quarter-inch jack of Mic/Inst Input 1. This is your DI (direct input). The quarter-inch jack has the proper impedance to accept a guitar signal. Mic your amplifier and connect the mic to Input 2. Connect any line output to your amp. Note that you may need a re-amp adapter with ground lift and transformer isolation, as shown, to remove noise (hum). You can also add pedals or other effects processors to the chain, as usual (after the adapter).

Recording for re-amping

For recording, set up your host DAW software to record Inputs 1 and 2 on separate tracks. Be sure that Patch Thru is disabled for these tracks in your DAW. In CueMix Pro, go to the Patchbay and connect Mic/Inst Input 1 to the line output connected to your amp. You should now hear your guitar through the amp and you're ready to record.

There is no latency because the signal is being looped directly from input to output in the 10pre mixer hardware (without the computer).

Re-amping after recording

To experiment with different guitar tones after recording, send the dry guitar signal to the same line output to feed it into a different amp, foot pedals or other favorite tone gear. Or apply amp and pedal plug-ins to the dry guitar track.

Optical I/O

The 10pre provides two banks of ADAT optical (“lightpipe”) connectors. Each bank provides an input and output connector. Together, they provide 16 channels of ADAT optical digital I/O at 44.1 or 48 kHz, or 8 channels of SMUX optical at 2x sample rates (88.2 or 96 kHz).

☛ The optical ports are disabled when the interface is operating at a 176.4 or 192 kHz.

TOSLink (optical S/PDIF)

Alternately, the Bank A optical ports can be configured for stereo TOSLink (optical S/PDIF) in the CueMix Pro app (item #5 on page 41 for input and item #9 on page 42 for output). The optical IN and OUT banks can be configured independently.

Choosing a clock source for optical connections

When connecting an *optical* device, make sure that its digital audio clock is rate-locked (in sync with) the 10pre, as explained in “Synchronization” on page 25 and “Syncing optical devices” on page 26.

Network connections

The network ports on the 10pre are standard Gigabit Ethernet ports that also support AVB.

If you are *not* using these ports as AVB ports (to stream audio to/from other devices over the network), you can use them as standard Ethernet ports for connecting the 10pre, along with your host computer (connected via USB or

Thunderbolt), to your local area network (LAN). For example, you could connect this port to a Wi-Fi router or Ethernet switch. This allows you to control the 10pre from iOS devices or other computers on the same network. This Ethernet connection also provides your host computer with access to the network. In essence, the 10pre acts as a Thunderbolt-to-Ethernet (or USB-to-Ethernet) adapter for your host computer.

If you do plan to use the 10pre’s AVB networking capabilities, please refer to the following:

- “Syncing AVB devices” on page 27
- chapter 9, “Networking” (page 71)

SYNCHRONIZATION

If you connect devices digitally to the 10pre, or if you need to synchronize the 10pre with an outside time reference such as word clock, you must pay careful attention to the synchronization connections and clock source issues discussed in the next few sections.

Do you need to sync?

If you will be using only the 10pre’s analog inputs and outputs (and none of its digital I/O), and you don’t need to resolve your system to external word clock, you don’t need to make any sync connections. You can skip this section.

Situations that require synchronization

There are two general cases in which you will need to resolve the 10pre with other devices:

- Synchronizing with other digital audio devices so that their digital audio clocks are *rate-locked*
- Resolving the 10pre to an external clock source

Synchronization is critical for clean digital I/O

Synchronization is critical in any audio system, but it is especially important when you are transferring audio between digital audio devices. Your success in using the digital I/O features on

the 10pre depends almost entirely on proper synchronization. The following sections guide you through several recommended scenarios.

Be sure to choose a digital audio clock master

When you transfer digital audio between two devices, their audio clocks must be rate-locked with one another, so that their clock rates don't drift with respect to one another over time. Otherwise, you'll hear clicks, pops, and distortion in the audio — or perhaps no audio at all.

There are two ways to achieve rate lock: slave one device to the other, or slave both devices to a third master clock. If you have three or more digital audio devices, you need to slave them all to a single master audio clock.

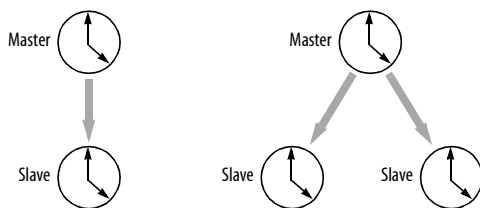

Figure 4-5: To keep the 10pre rate-locked with other digital audio devices connected to it, choose a clock master.

Also remember that audio rate lock can be achieved independently of timecode (location). For example, one device can be the timecode master while another is the audio clock master, but only one device can be the audio clock master. If you set things up with this rule in mind, you'll have trouble-free audio transfers with your MOTU hardware.

SYNCING OPTICAL DEVICES

There are several ways to sync an optical device with the 10pre:

- A. Resolve the other device to the 10pre
- B. Resolve the 10pre to the other device
- C. Resolve both devices to a word clock source

For A, choose *Internal* as the clock mode in the Device tab (item #6 on page 40). Then configure the other device to resolve to its optical input. Alternately, the MOTU interface could be resolved to any other external clock source besides *Optical*.

For B, choose *Optical* as the clock mode (item #6 on page 40), and configure the other device to resolve to its own internal clock.

For C, choose *Word Clock* as the clock mode for the 10pre (item #6 on page 40), and resolve the other device to its word clock input.

Using word clock to resolve optical devices

If the optical device has word clock connectors on it, you can use them to synchronize the device with the 10pre. See the next section, “Syncing word clock devices”.

SYNCING WORD CLOCK DEVICES

The word clock connectors on the 10pre allow you to synchronize it with a wide variety of other word clock-equipped devices.

For standard word clock sync, you need to choose an audio clock master (as explained in “Be sure to choose a digital audio clock master” on page 26). In the simplest case, you have two devices and one is the word clock master and the other is the slave as shown below in Figure 4-6 and Figure 4-7.



Figure 4-6: Slaving another digital audio device to the 10pre via word clock. For the 10pre clock source, choose *Internal* (or any source other than *Word Clock*, as daisy-chaining word clock is not recommended).



Figure 4-7: Slaving the 10pre to word clock. For the 10pre clock source, choose 'Word Clock In'.

The 10pre word clock input provides proper 75 ohm termination, but only when the BNC jack is configured to operate as a word clock output. Alternately, the word clock output can be configured as a word clock thru, which connects the input clock signal directly to the output, *with no termination on the input*. See the “Daisy-chaining word clock” below.

Resolving to a word clock signal that matches the 10pre base clock rate

The 10pre can resolve to a word clock signal running at an even multiple of the current system clock setting (the *base clock rate*). For example, the 10pre could be running at 96 kHz while resolving to a 48 kHz word clock signal from another device. Similarly, the 10pre could run at 88.2 kHz and resolve to 44.1 kHz word clock signal. Conversely, the 10pre could run at 48 kHz and resolve to a 96 kHz word clock signal. However, if the 10pre is running at 96 kHz, it cannot resolve to a word clock signal running at 44.1 kHz.

In summary, the word clock signal must be one of the following:

- the same as the current 10pre clock rate
- 2x or 4x the current 10pre clock rate
- half or quarter of the current 10pre clock rate

Daisy-chaining word clock

If necessary, you can daisy-chain several word clock devices together. When doing so, connect WORD CLOCK OUT from the first (master)

device to the WORD CLOCK IN on the second device. Then connect its WORD CLOCK THRU port to the next device’s WORD CLOCK IN port, and so on. If the 10pre is in the middle of the chain, use its WORD CLOCK OUT port and change its operation from OUT to THRU (using item #7 on page 40 or from the front panel menu). If the 10pre is the first device in the chain (to generate word clock for the other devices), do not enable WORD CLOCK THRU mode.

Make sure that the last device in the word clock chain has 75 ohm termination on its input.

If you have more than four word clock devices that you need to synchronize, try to avoid chaining their word clock connections. Instead, use a word clock distribution device of some kind.

☛ When the 10pre is powered off, the WORD CLOCK OUT reverts to THRU.

SYNCING AVB DEVICES

When connecting AVB streams between two or more devices on a network, one device needs to be designated as the clock master, while all other devices use it as a clock source. Set the master device’s Clock Source to *Internal* (or any other clock source besides an AVB network stream). Other devices should then resolve to the master device via an AVB stream connection.

For details about how to set this up between multiple 10pre’s, or between the 10pre and other AVB devices, see “Syncing AVB devices” on page 76.

Part 2

Using the 10pre

CHAPTER 5 Front Panel Operation

The front panel provides access to settings for the ten mic inputs, two headphone outputs with independent volume, and the 10pre’s control room features. The high-resolution LCD screen displays level meters for all inputs and outputs, status information and activity indicators for network activity. Basic device settings and status information can be accessed in the LCD using the MENU knob and SELECT/BACK buttons.

- Level meters29
- Menu Navigation30
- Headphone volume31
- Preamp controls31
- Monitor control31
- The Monitor Group32
- Mute and Mono32
- A/B/C Mode32
- Talkback34
- Saving and recalling device presets35
- DAC Filter35
- Front Panel Lockout35
- Power button36

LEVEL METERS

In its default state when the unit is first powered on, the LCD screen displays level meter activity for all audio inputs and outputs (Figure 5-2).

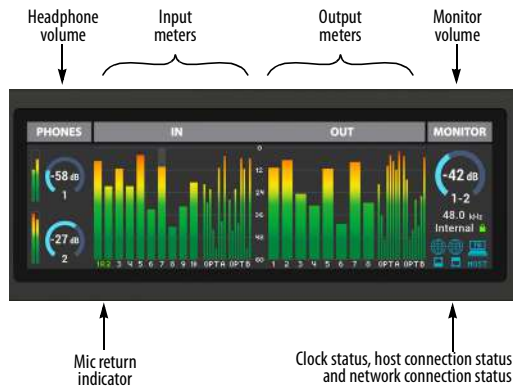

Figure 5-2: The front panel displays.

The Status section

The Status section (Figure 5-3) displays basic information about the 10pre.

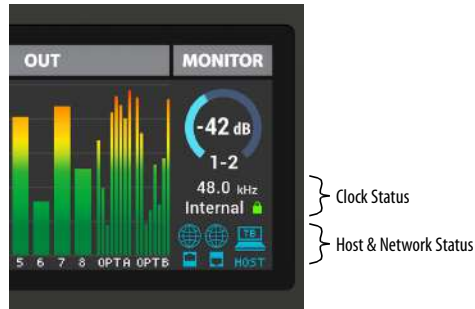

Figure 5-3: The Status section.



Figure 5-1: The 10pre front panel.

Clock Status





The Clock Status section of the screen (Figure 5-3) displays the *Sample Rate* at which the unit is currently operating, and the current *Clock Source* setting (item #6 in the Devices tab on page 40). The Sample Rate and Clock Source settings can also be found (and changed) in the front panel screen menu. They can also be changed in the Device tab of CueMix Pro (page 40).

The Lock icon

When the 10pre has successfully resolved to the current clock source, the *Lock* icon (Figure 5-3) turns *green*. When the 10pre has not yet successfully locked to the current clock source for some reason, the lock icon turns *red*. Check the *Clock Source* setting (item #6 on page 40), cable connections, etc. The lock icon can also appear *amber*. See “Clock source freewheeling” on page 77.



HOST Status

The *Host* icon (Figure 5-3) indicates the status of the USB-C connection to the computer, as shown below. *Blue* indicates a successful connection to the host; the number (or letters) indicates the format of the connection (Thunderbolt/USB4, USB3 or USB2). When the icon turns *yellow*, this indicates that a connection has been detected, but full connectivity has not yet been established for some reason.

Host connection status	Host icon
No connection	 (White)
Connection detected, but not yet fully established	 (Yellow)
Thunderbolt/USB4 (PCIe)	 (Blue)
USB3	 (Blue)
USB2	 (Blue)

Network Status

The *Network Status* indicators (Figure 5-3) turn blue when a network connection has been successfully established on the top or bottom network port on the rear panel of the 10pre.

Network connection status	Network icon
No connection	 (White)
Connection established	 (blue)

Meter views

Several alternative meter views are available, such as *All meters* and *Analog I/O only*. These can be chosen from the MENU (see the next section).

All meters



Analog I/O only



Digital I/O only



Figure 5-4: Meter views.

MENU NAVIGATION

Turn the MENU knob or push the SELECT button (Figure 5-1) to access the menu, which provides settings and status information. Turn the MENU knob to scroll through the menu settings.

Push SELECT to enter the selected sub-menu or to select the currently highlighted parameter. Push BACK to go to the parent menu.

To exit the menu entirely, push BACK repeatedly until the menu disappears from the display.

Menu Item	What it does
Sample Rate	Sets the sample rate for the device.
Clock Source	Sets the digital audio clock source for the device. See “Synchronization” on page 25.
Word Clock	Lets you configure the Word Clock OUT port as either OUT or THRU. See “Syncing word clock devices” on page 26.
Optical A Format	Specifies ADAT or TOSLink. See “Optical I/O” on page 25.
Optical Expander	Provides presets for optical expander operation at each sample rate (up to 96 kHz). See chapter 8, “Optical Expander Presets” (page 69).
Headphone 1 Source	Lets you choose the source signal for the Headphone 1 output.
Headphone 2 Source	Lets you choose the source signal for the Headphone 2 output.
Meter View	Lets you choose a desired metering configuration, such as <i>All Meters</i> , <i>Analog I/O Only</i> , etc.
Meter Settings	Lets you set the peak/hold time for the meters.
Display	Provides timeout options for the display (after 30 seconds, 30 minutes or off). When timed out, the screen goes dark.
Network	Displays the IP address and network clock source for the 10pre unit.
About	Displays the device name, serial number, and firmware version for the device.
Presets	Lets you save and recall device presets, which store the entire state of the interface. Up to eight different presets can be stored.
Advanced	Provides settings for the DAC filter and front panel lockout.
Reset	Restores factory default settings. Please note: doing a factory reset will erase any saved user presets. To restore factory settings without erasing saved user presets, see “The Default Preset” on page 35.

HEADPHONE VOLUME

Turn the headphone volume knobs (Figure 5-1) to adjust the volume of the corresponding headphone output. The LCD indicates the current level (on a scale from $-\infty$ to 0) and provides feedback during adjustment.

PREAMP CONTROLS

Use the INPUT knob to choose the mic input channel to adjust. The front panel LCD indicates the currently selected mic input channel with a slightly highlighted background, as shown below in Figure 5-5.

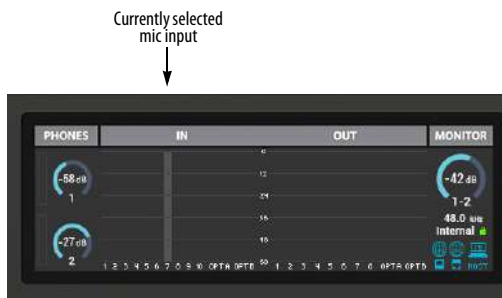

Figure 5-5: The currently selected mic input channel.

Use the 48V and PAD buttons to engage or disengage these features for the currently selected mic input channel. Turn the preamp GAIN knob to adjust the preamp gain in 1 dB increments. The LCD indicates the current level (from 0 to +74 dB) and provides feedback during adjustment.

MONITOR CONTROL

Turn the main volume knob (to the right of the LCD) to adjust the Monitor volume. From the factory, this knob controls the level of Line Outs 1-2. If you add additional outputs to the Monitor group (see below), this volume knob controls the output level of all of them.

THE MONITOR GROUP

The 10pre *Monitor Group* allows you to add additional line outputs to be controlled as a group by the main volume knob (and the corresponding volume control in the Home tab and Outputs tab in CueMix Pro). For example, you could group Outputs 1-6 or 1-8 to control a 5.1 or 7.1 surround system, respectively. Choose the desired outputs in the *Monitor Group* section in the CueMix Pro Home tab (page 39) or Outputs tab (page 42).

After doing so, the main volume knob (on both the front panel and in the CueMix Pro Home and Outputs tabs) affect all of them.

When A/B/C Mode is enabled, the Monitor Group controls all three pairs of A, B and C outputs. See “A/B/C Monitoring” on page 56. Use the trim controls in the CueMix Pro Outputs tab to trim Monitor Group outputs relative to each other.

MUTE AND MONO

Push MUTE (Figure 5-6) to temporarily silence all outputs currently included in the Monitor Group (Figure 5-6).

Push MONO (Figure 5-6) to temporarily sum the Main Output pair (or the A/B/C monitor pairs, if enabled) to mono. When summing to mono, the left and right channels are mixed together and the resulting mono audio stream is sent to both outputs of the stereo pair. The resulting mono signal is also attenuated by 3 dB to maintain the same overall loudness of the original stereo image.

If the Monitor Group currently has additional channels included in the group (beyond the Main Output pair), the MONO button affects only the Main Output pair. It does not affect any of the other Monitor Group outputs.

A/B/C MODE

The 10pre front panel provides controls for primary, secondary and auxiliary monitors in your studio, labeled A, B, and C, respectively (Figure 5-6).

These controls are also available in the CueMix Pro Outputs tab (page 42), so you can control them from your laptop, tablet or smartphone.



Figure 5-6: A/B/C Mode and Monitor controls on the front panel.

Output connections for Monitor A, B, and C

Each monitor pair can be connected to any outputs you wish: analog (line) outs, digital (optical) outs, or even network channels. Typically, they are connected as follows:

- Monitor pair A --> Line Outs 1-2
- Monitor pair B --> Line Outs 3-4
- Monitor pair C --> Line Outs 5-6

Once you’ve connected your speakers, visit the Patchbay tab or Routing tab in CueMix Pro (page 43 and page 44, respectively) to connect the A/B/C source signals to their respective outputs. In the example shown below in Figure 5-7, Monitor Pair A has been routed to Line Outs 1-2, Monitor Pair B to Line Outs 3-4, and Monitor Pair C to Line Outs 5-6.

⚠ Connecting the Monitor A/B/C source signals to mixer inputs can cause feedback loops and is not recommended. Connect them directly to physical outputs.



Figure 5-7: Routing the A/B/C Monitor source signals to their respective outputs. In this example, Monitor A is routed to Line Outs 1-2, Monitor B is routed to Line Outs 3-4 and Monitor C is routed to Line Outs 5-6. This is only an example; you can use any outputs you wish (analog, digital or even network channels).

In the Patchbay tab, the same connections shown in Figure 5-7 are shown below in Figure 5-8.

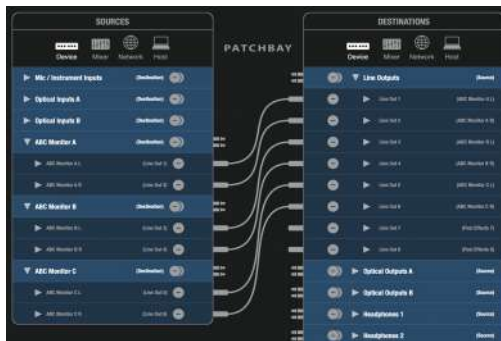

Figure 5-8: Using the Patchbay to route A/B/C source signals to their respective outputs (Line Outs 1-6 in this example). These are the same connections as shown in Figure 5-7.

Routing a source signal to the A/B/C channels

The final step in setting up A/B/C monitoring is to route a source signal, usually the main outs from the computer, to the ABC Monitor channels. From the factory, the 10pre routes computer output to the 10pre’s mixer, where it can be mixed with 10pre inputs and other signals. See “The factory default preset” on page 57 and “Playback from your DAW/host” on page 64. If this factory default

routing is still in place, route the mixer output (*Main 1-2*) to the ABC Monitor channels as shown in Figure 5-9 and Figure 5-10 below.



Figure 5-9: Routing host computer (DAW) output to the ABC Monitor channels (via the 10pre’s built-in mixer).

In the Patchbay tab, the same connections shown in Figure 5-9 are shown below in Figure 5-10.



Figure 5-10: Using the Patchbay to route host computer (DAW) output to the ABC Monitor channels (via the 10pre’s built-in mixer). These are the same connections as shown in Figure 5-9.

Enabling A/B/C monitor mode

Once connections and routing have been made as explained in the previous sections, you are ready to use A/B/C monitor mode. To enable A/B/C monitor mode, press the A, B, or C button. When enabled, the output channels in monitor group A, B, and C share the same audio signal (assigned to the channels in group A).

Monitor A/B/C select

To select a monitor pair and mute the other pair, press A, B, or C (Figure 5-6). Press them simultaneously to hear multiple sets of monitors at the same time.

Disabling A/B/C monitor mode

To disable A/B/C monitor mode, press the currently selected button (A, B, or C).

A/B/C volume control and separate trim

Control the volume of all three pairs of monitors with the main volume knob (to the right of the LCD). This knob controls all three pairs. To adjust their volume relative to one another, use their trim controls in the Outputs tab (item #7 on page 42).

TALKBACK

Talkback allows an engineer in the control room to temporarily dim or mute all audio and talk to musicians during a recording session. Talkback requires a microphone located in the control room, near the engineer.



↑
Mic effects

Figure 5-11: talkback settings can be found in the CueMix Pro Home tab.

Talkback setup

To set up talkback:

- 1 Plug in a microphone to one of the 10pre mic inputs. Enable 48V phantom power, if it is a condenser mic.
- 2 In CueMix Pro's Home tab, choose the mic input from the Source menu.

- 3 In the Destinations menu, check the outputs you wish to send the talkback signal to.

- 4 Adjust the Talkback settings as explained below.

Talkback settings

Talkback has the following settings (Figure 5-11).

Talk

Press and hold the *Talk* button (Figure 5-11) to engage the talkback mic. This is the same as pressing the TALK button on the front panel of the 10pre (item #16 on page 9).

Latch

When *Latch* is engaged (Figure 5-11), the Talk button remains engaged when you click it, until you click it again to disengage, so you don't have to hold it down while speaking. This setting also affects the TALK button on the front panel of the 10pre (item #16 on page 9).

Level

The Talkback *Level* setting controls the volume of the talkback signal, as an additional gain stage after the talkback mic preamp gain and pad.

Dim

If you are feeding a monitor mix to the musicians on the same Aux bus as your talkback mic, use the *Dim* knob (Figure 5-11) to control how much the monitor mix will be attenuated when talkback is engaged. This gives you control over the relative volume between the talkback mic signal and all other audio on the mix bus. To control overall volume of everything, use the bus fader.

Mic effects

Click the *Mic effects* thumbnails (Figure 5-11) for quick access to the EQ, compressor and gate effects for the mic input you are using for talkback. These are the same settings found in the mix tabs for that mic input (items #3 and 4 on page 47).

SAVING AND RECALLING DEVICE PRESETS

Use the MENU knob on the front panel to access the *Presets* menu command in the 10pre LCD to save and recall up to eight 10pre device presets in the device. A preset saves the entire state of the 10pre interface, including all device settings, mixes and effects settings. You can also manage presets in the Home tab of CueMix Pro. See “Custom presets” on page 59.

The Default Preset

The *Default Preset* restores the factory default settings of the unit while at the same time preserving any other presets you may have saved in the other preset slots. See “The factory default preset” on page 57.

DAC FILTER

The ESS™ digital-to-analog converter (DAC) in the 10pre provides state-of-the-art, industry leading performance. It also provides several filter settings that allow you to tailor the trade-offs between conversion latency, transient response, high-frequency roll-off, and phase linearity. These filter settings can be accessed from the front panel menu under the *Advanced* menu item. The three filter settings are summarized below.

☞ The differences between the filter settings are extremely subtle, and likely not perceptible, except in the most critical listening scenarios.

Minimum Phase (Default)

The *Minimum Phase (Default)* filter option is chosen as the factory default setting because it offers the best pass-band performance suitable for the widest range of audio material and very low converter latency of 5.4 samples. This option is your best choice if low latency is important for your workflows.

Linear Phase Fast

The *Linear Phase Fast* filter option has higher latency (35 samples) and pass-band performance similar to the minimum phase filter, with no frequency-dependent phase shifting. This is a good option if your use case benefits from linear phase (for example many D/A - A/D round trips) and the increased latency can be tolerated, or you can effectively manage latency with your system’s buffer setting (see “Reducing monitoring latency” on page 65).

Linear Phase Slow

The *Linear Phase Slow* filter has low latency (8.75 samples) and serves as an effective low-latency linear-phase option at higher sample rates (88.2khz or above).

FRONT PANEL LOCKOUT

The *Front Panel Lockout* feature can be enabled to prevent unwanted adjustments to the controls on the front panel of the 10pre. For example, the unit may be installed in a front-of-house mixing position in a theater, within arms reach of theater audience members.

To access the lockout feature from the front panel, Scroll to the *Advanced* menu item and choose the *Panel Lockout* sub-menu option.

Once enabled, the LCD displays an alert when any knob is turned (or button pushed) that the controls are locked.

There are two ways to exit Panel Lockout mode:

- On the front panel, hold down the BACK button while turning the MENU knob clockwise.
- In CueMix Pro, go to the Device tab and click the *Unlock Front Panel* button (Figure 5-12).



Figure 5-12: Disabling Front Panel Lockout mode in the Device tab in CueMix Pro.

POWER BUTTON

Push the power button to turn the unit on or off.

CHAPTER 6 CueMix Pro

CueMix Pro gives you complete control of all the settings in the 10pre. It is a standard software application installed on your Mac or PC when you run the MOTU Pro Audio v2 installer or setup app. It can be found in the Applications folder (Mac) or Start menu under MOTU (Windows).

CueMix Pro is also available as an iOS app.

Run the installer, get the app	37
Make hardware connections	37
Discovery tab	38
Home tab	39
Device tab	40
Inputs tab	41
Outputs tab	42
Patchbay tab	43
Routing tab	44
Mixing tab	45
Aux Mixing tab	46
Input channel strips	47
Bus channel strips	48
Input channel settings	49
Parametric EQ	50
Dynamics processing	51
Mix Sends	52
Mixer Effects	53
Multi-band parametric EQ	53
Gate	54
Compressor	54
Reverb	55
A/B/C Monitoring	56
Talkback	56
The factory default preset	57
Custom presets	59
Working with other MOTU AVB interfaces	59
Firmware Updating	59
The CueMix Pro iOS app	61

RUN THE INSTALLER, GET THE APP

Visit motu.com/10pre-start to get the latest MOTU Pro Audio v2 installer or setup and run it on your computer. Visit the Apple App Store to install the CueMix Pro app on your iOS device.

🔍 Look for updated PDF versions of this user guide at the link above, which may document new features and updates to CueMix Pro.

MAKE HARDWARE CONNECTIONS

Before running CueMix Pro, be sure that the 10pre is successfully connected to your device and powered on, and described in chapter 4, “Hardware Installation” (page 19).

DISCOVERY TAB

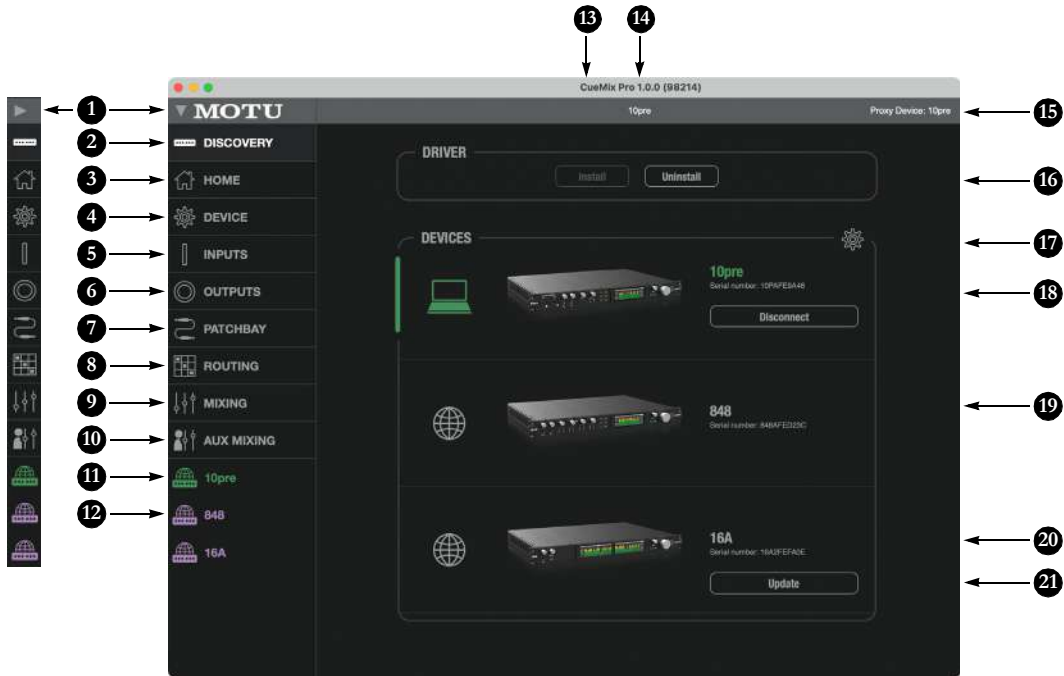

1. Expands and collapses the sidebar.
2. This is the *Discovery* tab. It lets you access and manage all 10pre's connected to your computer and local area network (LAN).
3. The *Home* tab provides quick access to basic settings. See "Home tab" on page 39.
4. The *Device* tab provides basic hardware settings, such as the Sample Rate and Clock Source. See "Device tab" on page 40.
5. The *Inputs* tab provides settings for the 10pre's physical inputs, such as gain levels for the line inputs. See "Inputs tab" on page 41.
6. The *Outputs* tab provides settings for the 10pre's physical outputs, such as trim levels for the line outputs. See "Outputs tab" on page 42.
7. The *Patchbay* tab provides flexible audio channel patching and routing among sources and destinations, including the computer, the 10pre physical inputs and outputs, the 64-channel mixer in the 10pre, and AVB network I/O streams.
8. The *Routing* tab is another way to manage audio channel patching and routing. See "Routing tab" on page 44.
9. The *Mixing* tab provides access to the on-board mixing and effects. The 10pre is a capable 64 x 32 monitor mixer. See "Mixing tab" on page 45.
10. The *Aux Mixing* tab gives you access to send faders for each aux mix. See "Aux Mixing tab" on page 46.
11. This is the currently selected device (highlighted in green). This is the device currently being viewed in the CueMix Pro app.
12. This area at the bottom of the sidebar displays any AVB devices on the same network as the currently selected (green) device here in the Discovery tab (18), which serves as the network proxy device (15). The sidebar list shows both MOTU and 3rd-party devices. Click a device to view its settings in CueMix Pro. When previous-generation MOTU devices or 3rd-party devices are selected, they will display only basic settings in CueMix Pro. Unavailable tabs will be grayed out.
13. The *Devices* list shows any 10pre's, 16A's or 848's detected by CueMix Pro. In the future, other similar products in the 10pre (Pro Audio v2) family will appear in this list as well, when detected by CueMix Pro.
14. The title bar displays the name of the 10pre or other device on the network that is currently being viewed in (and controlled with) CueMix Pro.
15. The *Proxy Device* provides access to any other AVB devices on the network. These devices are displayed in the sidebar (12).
16. (macOS only) The *Driver* section provides buttons for installing and uninstalling the 10pre driver, which supports the best possible performance for your 10pre.
17. This menu lets you show or hide a virtual 10pre in the device list. Clicking on the virtual 10pre lets you work with CueMix Pro off line, when no 10pre hardware is accessible or available (i.e. there is no 10pre present in the list of available devices). You can access all CueMix Pro settings in all tabs.
18. The *currently selected device* is displayed in green. Click a device to select it. This is the device that CueMix Pro is connected to. When you connect to a device here, you can view its settings in CueMix Pro. It also serves as the *Proxy Device* (15), providing access to all other AVB devices on the same network; network devices are displayed in the sidebar (12). Click *Disconnect* to sever the connection between the device and CueMix Pro. This can sometimes help when troubleshooting. Click the device again to reconnect.
19. Each device displays its connection type (host or network).
20. To rename a device, click it to select it and then go to the Device tab (4) to rename it there.
21. If a firmware update is available, this *Update* button appears. Click it to update the firmware in the device.

HOME TAB

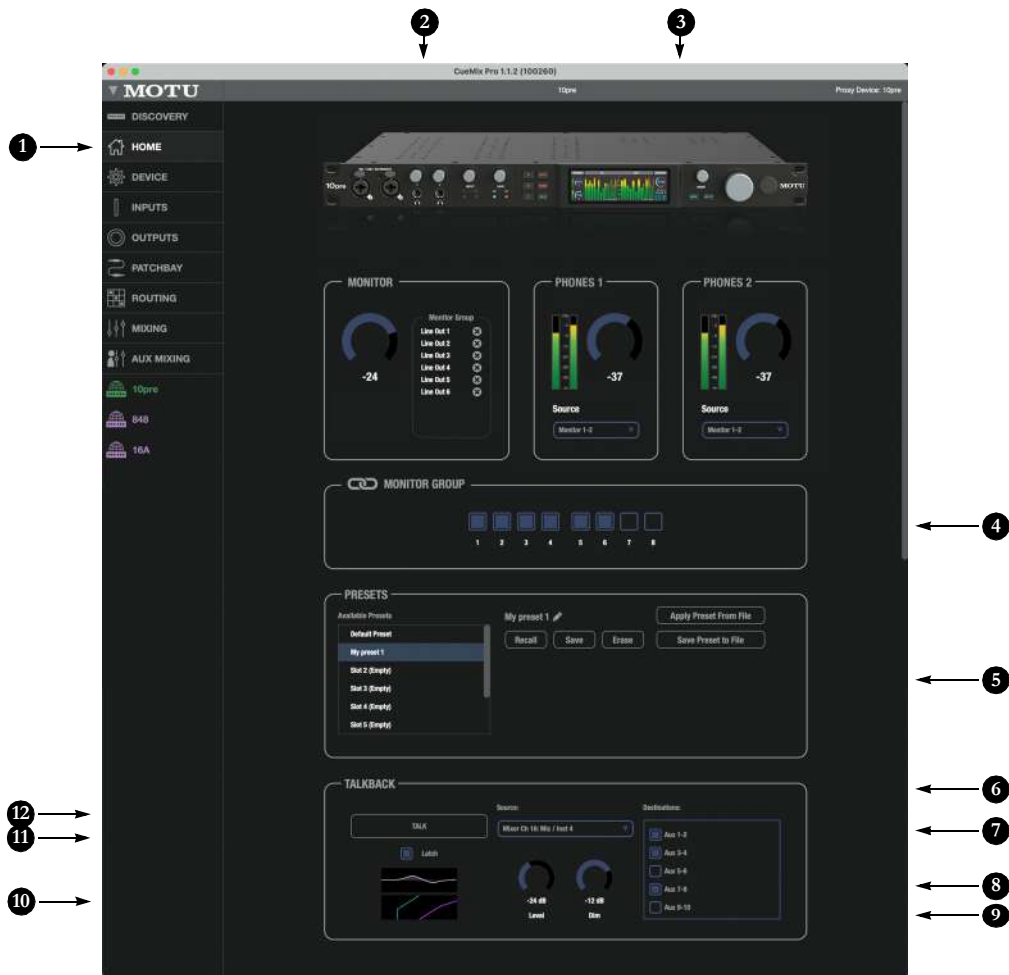

1. This is the *Home* tab, which provides quick access to basic settings.
2. Control the unit's *Monitor* volume here (the level of the Monitor Group). This is the same as the main volume knob on the front panel of the unit (item 11 on page 9).
3. Control the volume for the two *Headphone* outputs here. These are the same as the headphone volume knobs on the front panel of the unit (item 2 on page 9). You can also choose the source signal for each.
4. The *Monitor Group* represents line outputs that are dedicated to monitoring in your studio. From the factory, the Monitor Group includes

Line Outs 1-2, which you would connect to your primary studio monitors. You can add additional outputs for multi-channel monitoring. All outputs in the Monitor Group are controlled by the main volume knob on the front panel of the 10pre, and the Monitor Volume knob in this tab (2). You can adjust their relative volume to one another using the trims in the Outputs tab (page 42).

5. The *Presets* section lets you save, recall, and erase presets in the device's eight preset slots. You can also save and recall presets to and from your computer or iPad. See "Custom presets" on page 59.

6. The *Talkback* section provides controls for setting up and controlling the 10pre's talkback features. See See "Talkback" on page 56.
7. Use mixer buses to route the talkback signal to the desired destination in your studio. Select the bus you are using here in the *Destinations* list.
8. When engaged, Talkback can temporarily reduce the level of all other signals on the talkback bus. Use the *Dim* control to determine the signal reduction amount.
9. *Level* controls the volume of the Talkback signal.

10. Click the EQ and dynamics processing thumbnails to access a 4-band EQ, gate and compressor for the talkback signal.
11. Use the *Source* menu to choose the source signal for talkback, such as an analog input connected to a talkback mic.
12. Click the *TALK* button to engage talkback. If the *Latch* button is disabled, the TALK button will only engage while pressing on the button. With Latch enabled, you can click the TALK button and it will remain on until you click it again.

DEVICE TAB

- This is the *Device* tab, which provides basic hardware settings, such as the Sample Rate and Clock Source.
- You can give your 10pre a unique *Device Name*, which appears in the Discovery tab. This allows you to manage multiple devices that are connected or available on the network. Click to edit the name.
- Displays the *Serial Number* of your 10pre device.
- Displays the *firmware version* currently installed in your 10pre device. If an update is available, click *Update Now*. See “Firmware Updating” on page 59. Be sure to check frequently for updates for new features and enhancements.
- Choose the desired *Sample Rate*. Make sure your host audio software is set to the same rate.
- Choose the *Clock Source*. Your MOTU device will resolve its digital clock to this master source. Set the clock source to *Internal*, unless you have other devices connected to the optical inputs. If so, see “Optical I/O” on page 25. If you are resolving the 10pre to an external word clock source, choose *Word Clock*. See “Syncing word clock devices” on page 26. If you are working with other devices on an AVB network, see “Syncing AVB devices” on page 76. The *lock* icon indicates when the 10pre is successfully locked. Also see “Clock source freewheeling” on page 77.
- The *Word Clock* output on your MOTU interface can operate as an OUT or a THRU. When *Word Clock Thru* is enabled, 75 ohm termination on the input is lifted and the word clock signal received on the input is patched directly to the Word Clock Output. See “Daisy-chaining word clock” on page 27.
- Click the *Become AVB Media Clock Reference* button to make this device the clock reference for all other devices on the AVB network. All other devices will be resolved to the audio clock in this device. See “Syncing AVB devices” on page 76.
- (Windows only) Choose the desired *Buffer Size*. Smaller values reduce latency but increase your computer’s CPU load. See “Buffer Size” on page 18.
- (Windows only) Use the *Output Safety Offset* setting to fine tune host buffer latency. See “Output Safety Offset” on page 18.
- (Windows only) The 10pre supports Windows built-in audio. Choose the number of *WDM Input Streams* and *WDM Output Streams* you wish to use with your Windows audio applications that use built-in audio. These settings do not affect the ASIO driver channels.
- The 10pre provides sixteen *AVB Input Streams* for receiving audio from other AVB devices on the network. Each stream supports from one to eight audio channels. Use these menus to select the *Source Device* and *Source Stream* for each 10pre input stream. You can then use the Patchbay (page 43) to route the input streams elsewhere in the 10pre (to the host computer, the built-in 10pre mixer, 10pre outputs, etc.) See “Setting up the 10pre for networking” on page 74.
- (Not shown) The 10pre also provides sixteen *AVB Output Streams* (scroll past the Input Streams section to access them). Output streams allow you to send 10pre audio signals to other devices on the AVB network. Here in the Device tab, you can configure the number of audio channels for each output stream, and choose the stream format. See “AVB output stream format” on page 75 and “Setting up the 10pre for networking” on page 74.

INPUTS TAB



1. This is the *Inputs tab*, which provides access to settings for the 10pre analog and digital (optical) inputs.
2. The *Mic Inputs* section provides remote control of the 10pre's ten mic inputs and their preamps. These controls are the same as the GAIN knob on the front panel of the unit, along with the PAD and 48V switches. Here in the Inputs tab, each mic input is also equipped with a *Phase Invert* button. Click a mic input name to type in a custom name that will appear throughout CueMix Pro.
3. The 10pre mic inputs provide 74 dB of signal gain. The first 54 dB of gain occur before the insert point, while the final 20 dB occur after. Accordingly, when a plug is inserted into the insert RETURN jack for Mic/Inst inputs 3 or 4, CueMix Pro provides two separate gain knobs, as shown here.
4. Meters are provided here for the two Optical Input banks, for convenience.
5. Configure the *Optical Input format* for Bank A for either 8-channel ADAT or stereo TOSLink. At 88.2 or 96 kHz, the ADAT setting supports 4-channel SMUX format. Note that you can choose a different format for the optical IN and OUT ports. See "Optical I/O" on page 25.

OUTPUTS TAB

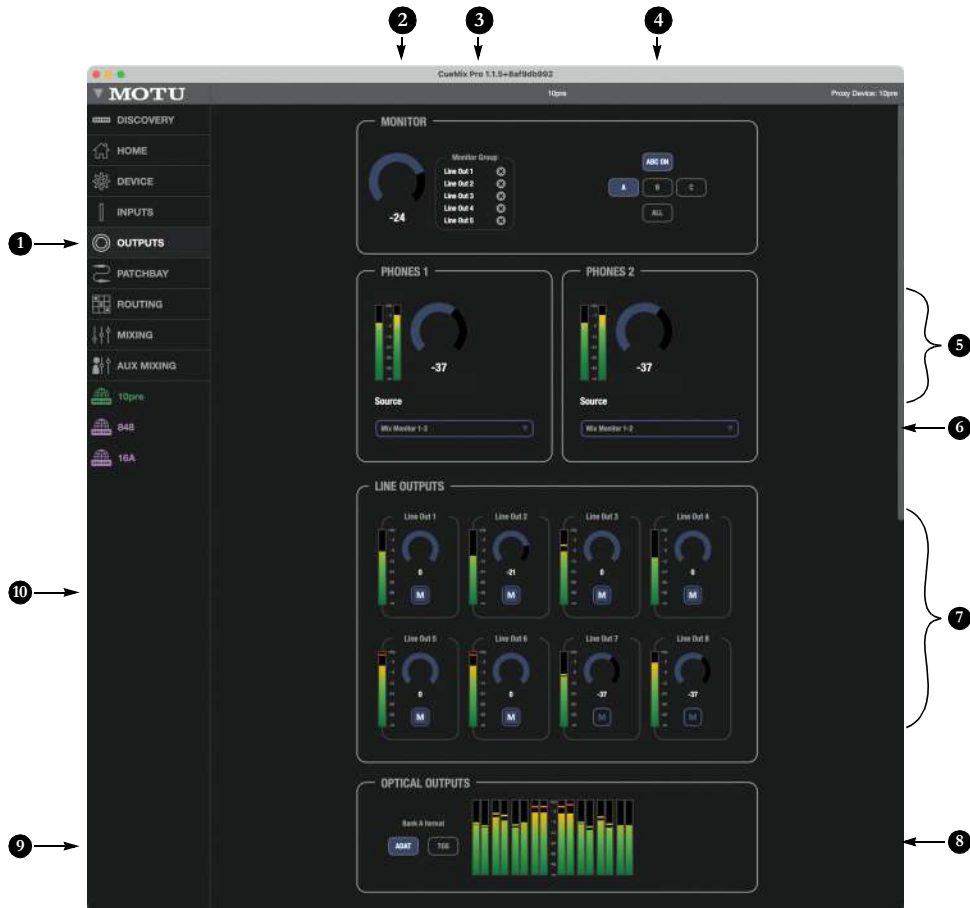

1. This is the *Outputs* tab, which provides settings for the 10pre's analog and digital outputs.
2. MONITOR volume controls the level of the monitor group. This is the same as the main volume knob on the front panel of the 10pre and in the Home tab (item #2 on page 39).
3. The *Monitor Group* determines which outputs are controlled by the *Main* volume knob on the 10pre's front panel (item #11 on page 9), plus the Main Volume controls in the Home tab (item #2 on page 39) and here in the Outputs tab. For example, if your studio has a pair of main monitors, plus a sub-woofer connected to Line Out 3, you could click the 'M' button for *Line Out 3* to add it to the main volume controls. If you have 5.1 or 7.1 surround monitoring, you can add the surround channels to the monitor group to be able to control the volume of all surround outputs simultaneously with the Main Volume knob.
4. *A/B/C Monitoring* lets you connect two or three sets of speakers and then check your mixes on each pair by switching among them using the A, B and C buttons. See "A/B/C Monitoring" on page 56.
5. Meters and volume controls for the *Headphone* outputs. These are the same as the headphone volume controls on the front panel.
6. Choose the *Source* signal for the headphone outputs from these menus. From the factory, these are set to the *Monitor 1-2* bus, which follows the 10pre's *Main 1-2* mix bus, which feeds *Line Outs 1-2*.
7. All *Line Outputs* can be trimmed from zero to $-\infty$ dB. This can be useful for speaker calibration or other situations where you need a fixed amount of level adjustment for a particular output (or output pair). You can also rename each output. Click the name to type in a custom name.
8. Meters are provided here for the two Optical Input banks, for convenience.
9. Configure the *Bank A format* for either 8-channel ADAT or stereo TosLink. At 88.2 or 96 kHz, the ADAT setting supports 4-channel SMUX format. Note that you can choose a different format for the IN and OUT. See "Optical I/O" on page 25.
10. Enable the 'M' button to include the output in the *Monitor Group*. The *Monitor Group* represents line outputs that are dedicated to monitoring in your studio. From the factory, the *Monitor Group* consists of *Line Outs 1-2*, which you would connect to your primary studio monitors. You can add additional outputs for multi-channel monitoring. All outputs in the *Monitor Group* are controlled by the main volume knob on the front panel of the 10pre, the *Monitor Volume* knob in this tab (2), and the Home tab (item #2 on page 39). You can adjust their relative volume to one another using the trims (7).

PATCHBAY TAB

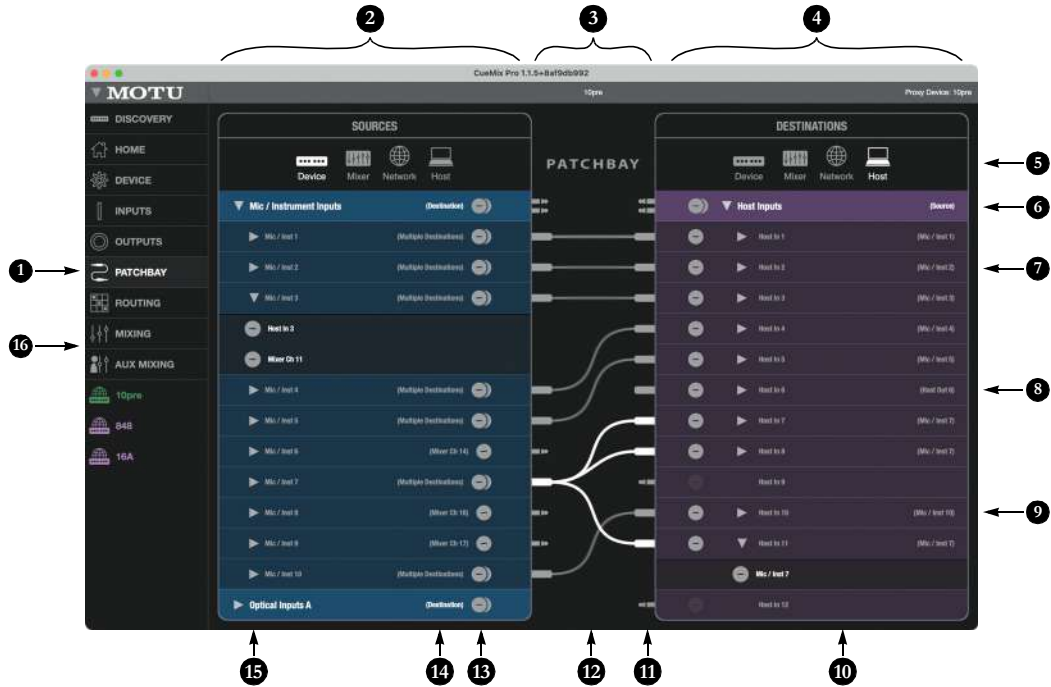

1. This is the *Patchbay* tab, which lets you make connections between audio sources and destinations in your 10pre system.

2. This bank on the left represents *Sources*, which are presented in four separate sub-banks:

Device — Analog and digital (optical) inputs on the 10pre device itself.

Mixer — Bus outputs from the 10pre's built-in mixer, which has 32 output buses.

Network — Incoming AVB audio streams from other devices on the network.

Host — Thunderbolt or USB audio channels from the host computer.

Channels are grouped into banks that can be collapsed or expanded.

3. This is the *Patchbay*, where you drag cables from one bank to the other to make connections, just like a real patchbay. Grab a cable from either side and snap it into any desired socket on the other side. To grab several cables at once, press and hold your mouse on the first one and

then drag down or up to select additional adjacent cables; then drag them together. To grab an entire bank, such as all *Line Inputs*, drag its “double” cables next to the bank name. To clear a connection, click it to select it and hit the delete key. To select multiple connections, drag across them.

When making or clearing connections, you can use *Undo* and *Redo* in the Edit menu.

4. This bank on the right represents *Destinations*, which are presented in four separate sub-banks:

Device — Analog and digital (optical) outputs on the 10pre device.

Mixer — Inputs to the 10pre's built-in 64-channel mixer.

Network — Outgoing AVB audio streams to other devices on the network.

Host — Thunderbolt or USB audio channels to the host computer.

5. Click the desired source or destination bank here to view it.

6. This is the *Host (computer) Inputs* bank, which represents Thunderbolt or USB audio channels going to the host computer. It is currently expanded so you can see individual channels below. The “double cable” in the Patchbay lets you connect all channels in this bank in one operation.

7. Here, the 10pre's Analog *Mic/Inst* In channel 2 is connected to *Host In* channel 2. This connection routes audio from Mic Input 2 to Thunderbolt (or USB) input channel 2 in your host software. Click any source or destination name to rename it.

8. Here, you see a plug connected to *Host Input 6*, but no cable. This indicates that there is a connection from a source in a different source bank, other than the *Device* inputs. To view this connection, click its source bank in the left panel.

9. Each destination shows its source in parentheses here (if there is one). Destinations can only have one source.

10. To see more connections, drag vertically on a bank to scroll it, or use the scroll wheel on your mouse (or your finger on iOS).

11. Drag any plug on either side of the patchbay to make a connection.

12. The white connections are selected; hit the delete key to clear them. To select a connection, click it. To select several, drag over them. Use the scroll wheel on your mouse while hovering over the patchbay to scroll both banks. Hold the Ctrl key while doing so to scroll them relatively.

13. Click the minus (-) button to clear a connection; click the double-minus to clear all connections for the source. Click the expand button (15) to delete individual connections.

14. The destination is shown here. To view multiple destinations, click the disclosure button (15).

15. Use the disclosure buttons to see what the source is connected to. Sources can be connected to multiple destinations, either in the same bank or other banks. Shortcut: Cmd/Ctrl-click to expand (or collapse) all.

16. In this example, *Mic/Inst In 3* is being patched to *Host In 3* and *Mixer Ch 17*. The mixer connection is not currently shown, but if you switch the destination bank to mixer (on the right) you'll see it then. Click the minus buttons to clear connections.

ROUTING TAB

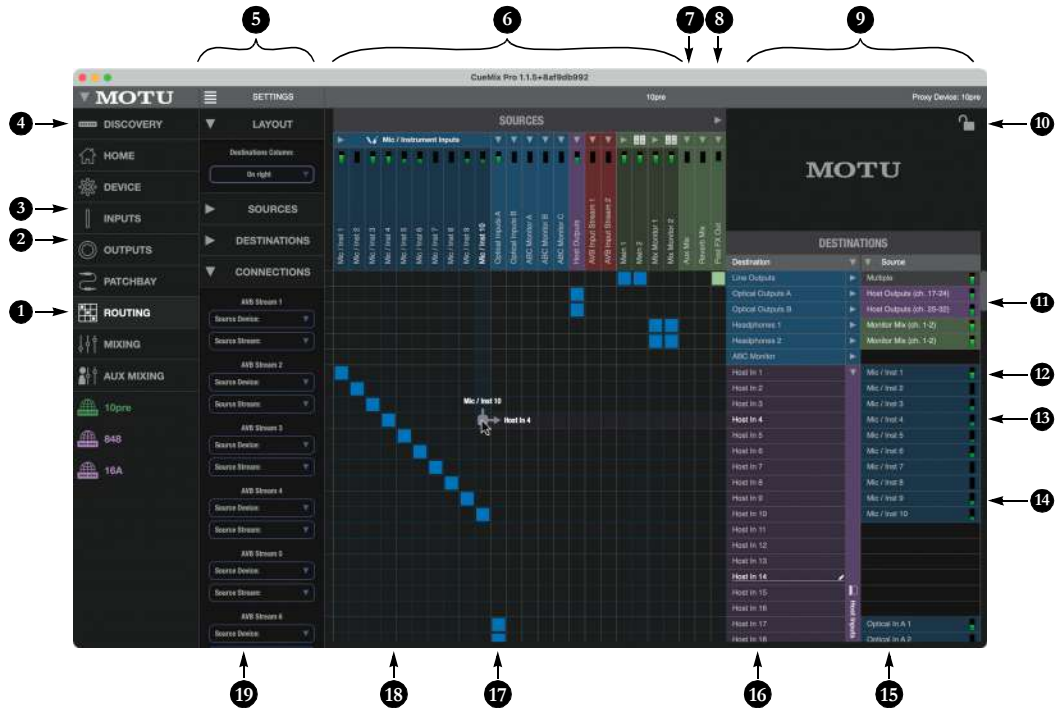

1. This is the *Routing* tab, which, similar to the *Patchbay*, lets you make connections between audio sources and destinations in your 10pre system. The grid in *Routing* tab provides more of a bird's-eye view, making it ideal for complex routing scenarios.
2. Use the *Destinations* section in the sidebar to show or hide destination banks (9).
3. Use the *Sources* section in the sidebar to show or hide source banks across the top of the grid (6).
4. The *Layout* section in the sidebar provides a setting to display the *Destinations* columns along the left side of the grid, if desired, similar to the web app for earlier generation MOTU AVB interfaces.
5. Click *Settings* to show or hide the *Settings* sidebar.
6. *Sources* are displayed as columns across the top of the grid, grouped in color-coded banks that match those in the *Patchbay* (page 43), as follows:

Blue (Device) — Analog and digital (optical) inputs on the 10pre device itself.

Purple (Host) — Thunderbolt or USB audio channels from the host computer.

Red (Network) — Incoming AVB audio streams from other devices on the network.

Green (Mixer) — Bus outputs from the 10pre's built-in mixer, which has 32 output buses.

7. Click a bank to expand or collapse it. Expanded banks show all channels in the bank.
8. Click this disclosure triangle to expand or collapse all source banks.
9. *Destinations* are displayed as rows here on the right, also grouped in color-coded banks matching the *Patchbay*. The *Layout* setting (4) allows you to display *Destinations* on the left side of the grid, if desired.
10. Locks the grid to prevent accidental changes. Unlock to make changes to the grid.

11. Here, the two *Optical Output* banks are currently collapsed, but the blue check box indicates the existence of multiple routings within each bank (from the host computer).

12. Here, the *Host Inputs* bank is expanded, showing each host input channel and its source.

13. Hover your cursor (or finger on iOS) over the grid and then click (or tap) to make a connection. Cursor tracking shows the source and destination connected by the grid box. Click an existing blue box to remove it (break the connection). Drag to make (or break) multiple connections in a single gesture.

>> Note that sources can be assigned to multiple destinations (in the same column), but each destination (row) can have only one source.

14. Each source and destination channel has its own level meter to indicate signal activity.

15. When making connections, the *Source* column shows the selected source for each destination, so you can view them by name, side by side. If there is no source, the *Source*

column is blank. Show or hide the *Source* column with the disclosure triangle in the column header.

16. Click any channel name to rename it. To revert to the default name, delete the custom name.

17. Here, *Optical Bank A* is collapsed, but you can still see grid boxes, which indicate connections within the collapsed bank. The destination for each channel in the bank is shown on the right. If you click a collapsed grid box, all channels within it are disconnected. If you click on a collapsed empty grid box, all channels within the bank are connected sequentially to the channels in the destination bank, if possible.

18. This angled line of check boxes shows that all 10pre analog inputs (1-10) are routed to the host computer (host input channels 1-10).

19. The *Connections* section in the sidebar let's you configure AVB streams. These settings are the same as found in the *Device* tab and are duplicated here for convenience while doing routing work.

MIXING TAB



- The *Mixing tab* gives you access to the 10pre's 64-channel 32-bus mixer. The mixer provides 64 input channel strips, followed by 32 bus faders. Scroll horizontally to view them. The current bus fader and its channel strip (*Main 1-2* by default) stays pinned to the right side of the window (5). It can be changed to any bus using the *On Faders* setting (17).
- Click the *Mix Settings* menu icon to open (or close) this sidebar. The top three items (*Channels*, *Buses*, and *Sections*) let you show and hide channels strips and sections. For example, you can hide inputs you are not using, or the *Compressor/Limiter* thumbnails. Click their disclosure triangle to view each list. The *Auto* setting in the *Sections* list, when enabled, will show and hide sections automatically, depending on the vertical size of the window.
- This is the mix bus currently being controlled with the faders, as determined by the *On Faders* setting (17).
- This is an *input channel strip*. For details, see "Input channel strips" on page 47. There are 64 input channels, which you can show or hide using the *Channels* sidebar section (2). If you scroll to the right of the input channels, you'll see 32 bus faders, including the reverb bus, 26 aux busses, the *Monitor* bus, and the *Main 1-2* bus. For details, see the sections later in this chapter.
- This output bus channel strip is always pinned to the right side of the window. By default, it shows the *Main 1-2* bus channel strip, but it can be changed to any bus using the *On Faders* setting (17).
- For input channels, this displays the source signal for the input. For bus channel strips, this shows the name of the bus. Click it to type in a custom name for the channel or bus.
- Thumbnail for the *channel settings*, such as source signal and High Pass Filter. Click to access the settings.
- Thumbnail for the *4-band EQ* for the channel or bus. Click to access the graphic EQ controls.
- Thumbnail for *dynamics processing* for the channel or bus. Inputs have a gate and both inputs and busses have a compressor. Click to access graphic controls.
- Send fader* thumbnail that shows any send faders that are up for the input. Click to access all send faders for the input, consolidated in one window. See "Mix Sends" on page 52.
- Pan control* for mono input channels. Inputs that are grouped as stereo pairs do not have this pan control. To create stereo pairs, click the channel settings (7) for one of the two channels or any thumbnail.
- Channel or bus fader and level meter*. The fader range is from $-\infty$ dB to $+12$ dB. Double-click the fader to jump to unity gain or $-\infty$. Level meters are pre-fader.
- Fader level* in dB. Click to edit it numerically.
- Solo* the input or bus here. Soloed channels and busses are routed to the *Solo bus*, which can be monitored via the *Monitor 1-2* bus. See "Bus channel strips" on page 48. Glide horizontally across multiple channels to solo them in one gesture.
- The *Talkback* section provides access to the Talkback controls here in the *Mixing* tab. See "Talkback" on page 56.
- The *On Faders* section lets you temporarily convert the faders in the input channel strips into send faders for the chosen bus, providing a convenient way to route multiple inputs to the bus. This includes the reverb bus, for routing input signals to the 10pre's built-in reverb. See "Reverb" on page 55. To bring the faders back to controlling input level, choose *Main 1-2* in the *On Faders* list. When a bus is chosen in the *On Faders* list, the channel strip pinned to the right side of the window changes to the fader and channel strip for the chosen bus. Choose *Main 1-2* to revert it back to the *Main 1-2* bus.
- The *Aux Buses* list provides controls for configuring aux busses as mono or stereo pairs. The *Reverb* bus is always stereo. You can also specify the sends for each bus as *pre-fader* (PRE on) or *post-fader* (PRE off). This setting applies globally to all send faders to the bus.

AUX MIXING TAB



1. The *Aux Mixing* tab provides quick access to the mixer's 26 aux buses and reverb bus, viewed one at a time. Choose a bus in the *On Faders* section of the settings sidebar (2) and then use the faders to directly mix the send levels for all 64 mixer inputs.
2. Use the *On Faders* list to choose which aux bus to work with here in the *Aux Mixing* tab. In this example, the faders for each input are sends to the *Aux 3-4* bus.
3. Use the *Channels* list in the sidebar to show or hide input channel strips here in the *Aux Mixing* tab.
4. Click the *Aux Mix Settings* menu icon to open (or close) this sidebar.
5. This area of the title bar shows the name of the current aux mix you are working with here in the *Aux Mixing* tab.
6. This is one of 64 *input channel strips*. It provides a send fader and pan control for the input. These two controls (volume and pan) are for the send only, not the input channel.
7. This is the bus fader for the aux bus currently being viewed here in the *Aux Mixing* tab (as determined by the *On Faders* selection). It is always pinned to the right side of the window.
8. This is the source signal for the input.
9. This is the *Pan* control for mono input channels. Inputs that are grouped as stereo pairs do not have this pan control. To create stereo pairs, click the channel setting (item #7 on page 45) for one of the two channels, or any thumbnail.
10. Channel *send fader* and *level meter*. Double-click the fader to jump to unity gain or $-\infty$. Level meters are pre-fader.
11. *Fader level* in dB.

INPUT CHANNEL STRIPS

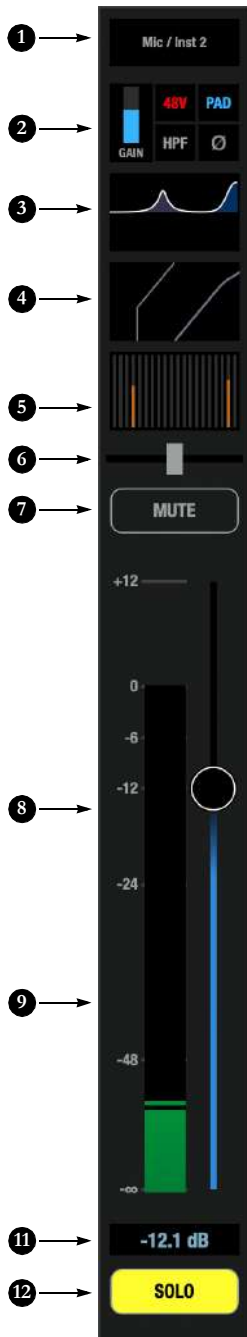

1. This displays the source signal for the input. If the channel strip is stereo, it will display the names of both the left and right channel source signals. Click it to rename it. To clear the custom name and return to the default name(s), select the custom text and hit the delete key. To change the source signal, click the channel settings thumbnail below (2).
2. Click this channel settings thumbnail to access basic channel settings, like the source signal and High Pass Filter. See "Input channel settings" on page 49.
3. Click this EQ thumbnail to access the parametric EQ and other channel settings. See "Multi-band parametric EQ" on page 53.
4. Click this dynamics processing thumbnail to access the *Gate*, *Compressor* and other channel settings. See "Compressor" on page 54 and "Gate" on page 54.
5. This is a *Send fader* thumbnail that shows any send faders that are up for the input. Click to access all send faders for the input, consolidated in one window. See "Mix Sends" on page 52.
6. *Pan control* for mono input channels. Inputs that are grouped as stereo pairs do not have this pan control. To create stereo pairs, click the channel settings (1) for one of the two channels or any thumbnail.
7. Channel mute. Glide horizontally across multiple channels to mute them in one gesture.
8. The peak/hold indicator shows where the signal has recently peaked.
9. The level meter for each input is pre-fader.
10. Use the channel fader to control the input level. The fader range is from $-\infty$ dB to +12 dB. Double-click the fader to jump to unity gain or $-\infty$. Level meters are pre-fader.
11. The fader value displayed numerically.
12. *Solo* the input here. Soloed channels are routed to the *Solo bus*, which can be monitored via the *Monitor 1-2* bus. See "Bus channel strips" on page 48. Glide horizontally across multiple channels to solo them in one gesture.

BUS CHANNEL STRIPS

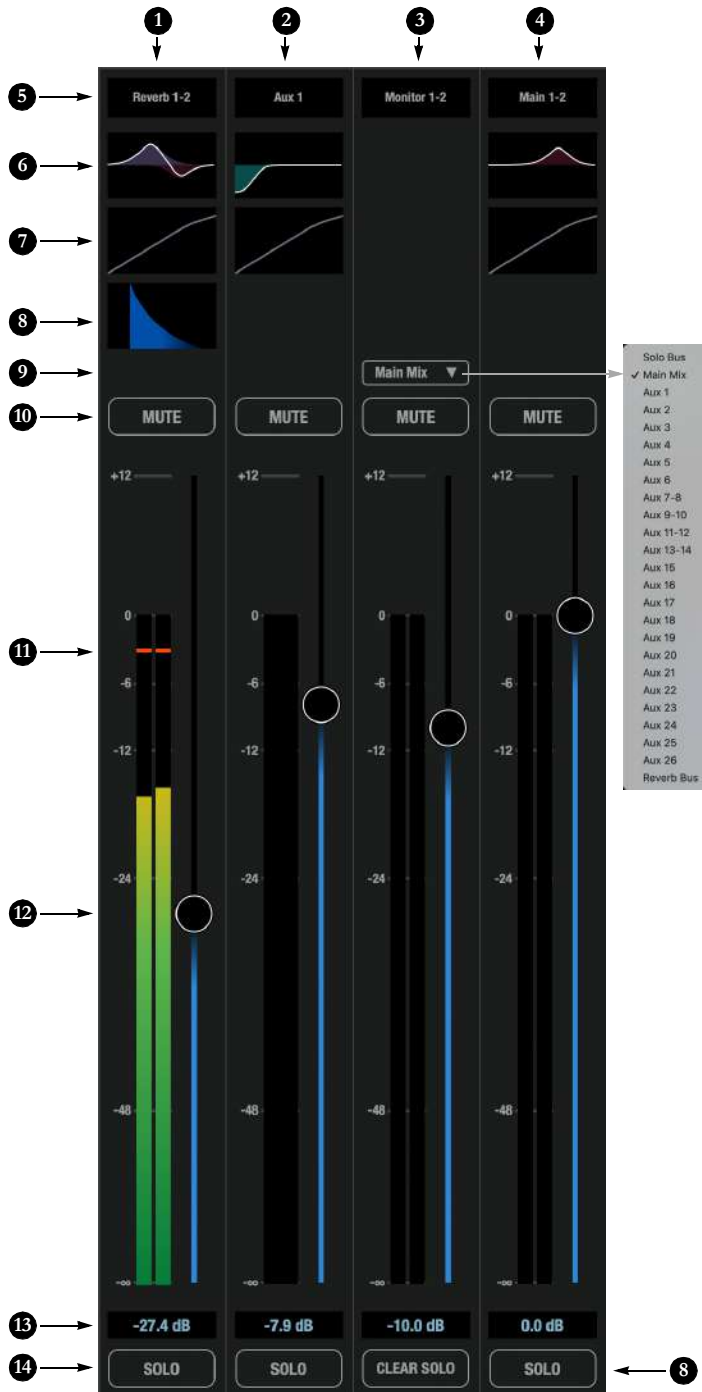

1. The *Reverb* bus sends input signals to the reverb processor (8). The resulting stereo output from the reverb should be routed to a mixer input, where it can be added to the main mix or any aux mix (via sends).
2. The mixer has 26 *Aux* buses that you can use for flexible mixing and routing.
3. The *Monitor 1-2* bus is dedicated to the role of monitoring. You can use the menu (shown below) to make the Monitor bus follow the Main Mix, the Reverb bus or any Aux bus. When any input or bus is soloed, the Monitor bus temporarily follows the *Solo Bus* (until all solos are cleared). If you choose Solo Bus from this menu, the Monitor bus always follows the Solo Bus, even when nothing is soloed. Note that the Monitor bus has no dedicated EQ or dynamics processing, as those functions can be applied to the bus it is following (except the Solo bus, which would never need them).
4. This is the *Main Mix* bus for the mixer.
5. This is the *name* of the bus. Click it to type in a custom name.
6. Click this *EQ thumbnail* to access the parametric EQ and other bus settings. See “Multi-band parametric EQ” on page 53.
7. Click this *dynamics processing* thumbnail to access the bus compressor and other bus settings. See “Compressor” on page 54.
8. Click the *Reverb* thumbnail to access the settings for the reverb processor. See “Reverb” on page 55.
9. Use the *Follow* menu in the Monitor bus channel strip to choose which bus the Monitor bus should follow, as shown in the menu to the left. See item #3 above for further explanation of this menu.
10. Bus mute. Glide horizontally across multiple buses to mute them in one gesture.
11. -The peak/hold indicator shows where the signal has recently peaked.
12. Use the fader to control the bus level. Double-click to return to $-\infty$ or unity gain.
13. The fader value displayed numerically.
14. *Solo* the bus here. Soloed buses are routed to the *Solo bus*, which can be monitored via the *Monitor 1-2* bus (9). Glide horizontally across multiple buses to solo them in one gesture.
15. Use the Clear Solo button in the Monitor bus channel strip to clear all solos.

INPUT CHANNEL SETTINGS



Click any of the items at the top of an input channel strip (items #1, 3, or 4 on page 47) to access the Channel Settings shown here.

1. Click the *Channel Strip* heading to show or hide this Sidebar, which displays basic settings for the channel and provides tabs for the channel's 4-band EQ, dynamics processing and send faders.
2. Choose the signal source for the input channel here. The menu at the top of the list lets you browse four possible banks of source signals as shown: *Device*, *Mixer*, *Network*, or *Host*. In fact, you can route signals to this mixer input in the Patchbay tab using those same banks of sources.
3. Use the *channel source* bank menu to access the desired input signal for the mixer input.
4. This is the *Channel Name*. By default, it displays the source signal for the channel. If the channel strip is stereo, it displays the names of both the left and right channel source signals. Click it to rename it. To clear the custom name(s) and return to the default name(s), select the custom text and hit the delete key. To change the source signal, use the *Channel Source* list below (2).
5. These are the input settings for the selected source signal, if any. For example, if you choose an 10pre mic/inst input, you'll have access to the preamp gain, 48V phantom power, -20 dB pad and phase invert controls, as shown here. These are the same controls as available in the Inputs tab (item #2 on page 41).
6. Click this "x" to close the settings and return to the mixer.
7. *High-Pass Filter* (HPF) for the channel. The HPF is applied first, before any other processing.
8. The *Mixer pane* shows faders for all mixer inputs and busses, so you can access them while adjusting channel settings for a specific channel above. Click on any channel strip to access the settings for that input or bus.
9. This is the currently selected channel. Click any channel to view its channel strip settings.
10. This is the complete channel strip for the currently selected channel or bus. Use the tabs at the top of the strip to access basic settings, EQ, dynamics and bus sends.
11. The *Stereo* button links or unlinks the channel to an adjacent channel for stereo pairing.
12. Click *Mix Sends* to access all *bus sends* for the channel.
13. Click *Dynamics* to access the channel's *Compressor* and *Gate*.
14. Click *Parametric EQ* to access the channel's *Parametric EQ*.
15. Click *Settings* to access the basic settings show above for the channel.

PARAMETRIC EQ



Click any of the items at the top of a channel strip (items #1, 3, or 4 on page 47 for an input or items 5, 6 or 7 on page 48 for a bus) to access the Parametric EQ and other settings for the channel.

1. Click the *Parametric EQ* tab here in the channel strip sidebar to access the 4-band parametric EQ settings shown here. For further information, see “Multi-band parametric EQ” on page 53.

2. Drag the *Frequency/Gain* handle for an EQ band to change the frequency and/or gain for the band.
3. Drag the *Q (bandwidth)* handles for an EQ band to change them. The handles are color-coded to match the color of their respective EQ band.
4. This is the *Channel Name*. Click it to type in a custom name.
5. Click this “x” to close the settings and return to the mixer.

6. Click the “power” icon to enable or disable the EQ band.
7. Click values to edit them numerically. You can also drag vertically on them to change them.
8. Click the *Notch/Shelf* switches to toggle the filter type.
9. The *Mixer pane* shows faders for all mixer inputs and busses, so you can access them while adjusting the EQ

for a specific channel above. Click on any channel strip to access the settings for that input or bus.

10. This is the currently selected channel. Click any channel to view its channel strip settings.
11. This is the complete channel strip for the currently selected channel or bus. Use the tabs at the top of the strip to access basic settings, EQ, dynamics and bus sends.

DYNAMICS PROCESSING



Click any of the items at the top of a channel strip (items #1, 3, or 4 on page 47 for an input or items 5, 6 or 7 on page 48 for a bus) to access the dynamics processing and other settings for the channel.

1. Click the *Dynamics* tab here in the channel strip sidebar to access the *Gate* and *Compressor* shown here.
2. The *Gate* processor is available on mixer input channels only. See “*Gate*” on page 54. Use the “*power*” button to enable or disable the gate.
3. Drag the *Threshold* handle to adjust it graphically.
4. This is the *Channel Name*. Click it to type in a custom name.
5. The *Compressor* is available on all mixer inputs and busses. See “*Compressor*” on page 54. Use the “*power*” button to enable or disable the compressor.
6. Drag the *Threshold* and *Ratio* handles to adjust them graphically.
7. Click this “x” to close the settings and return to the mixer.
8. Click values to edit them numerically. You can also drag on them vertically to change them.
9. The *Mixer pane* shows faders for all mixer inputs and busses, so you can access them while adjusting the dynamics processors for a specific channel above. Click on any channel strip to access the settings for that input or bus.
10. This is the currently selected channel. Click any channel to view its channel strip settings.
11. This is the complete channel strip for the currently selected channel or bus. Use the tabs at the top of the strip to access basic settings, EQ, dynamics and bus sends.

MIX SENDS



Click any of the items at the top of an input channel strip (items #1, 3, or 4 on page 47) to access the Mix Sends shown here.

1. Click the *Mix Sends* tab here in the channel strip sidebar to access the send faders shown across the top of this window.
2. Click this “x” to close the settings and return to the mixer.
3. This scrolling pane shows pan sliders and send faders for each mix bus. To send input signal to the bus, just bring up the fader. Double-click the fader to jump to unity gain or $-\infty$. Level meters are pre-fader.
4. The *Mixer pane* shows faders for all mixer inputs and buses, so you can access them while adjusting the sends for a specific channel above. Click on any input channel strip to access the settings for that input. Sends are not available for buses. (You can't send a bus to another bus).
5. This is the currently selected channel. Click any channel to view its channel strip settings.
6. This is the complete channel strip for the currently selected channel or bus. Use the tabs at the top of the strip to access basic settings, EQ, dynamics and bus sends.

MIXER EFFECTS

The high-pass filter, parametric EQ, compressor, gate, and reverb processor in the 10pre are available when operating the unit at 1x and 2x samples rates. At 4x sample rates (176.4 or 192 kHz), all effects processing is disabled, but the mixer still provides 64 inputs and 32 buses.

DSP-driven mixing and effects

The 10pre effects are driven by a powerful DSP that delivers 32-bit floating point precision and plenty of bandwidth for no-latency processing. Effects can be applied when operating as an audio interface or as a stand-alone mixer.

Advantages over host-based mixing and processing

The hardware mixer in the 10pre provides several advantages over mixing and processing in your host audio software:

- No buffer latency. The DSP-mixer provides the same near-zero latency throughput performance as a conventional digital mixer. Effects processing doesn't impact your computer's CPU.
- DSP mixing and routing can be maintained independently of individual software applications or projects.
- Monitoring is maintained during computer related disruptions (such as switching from one DAW project to another, for example).
- DSP-driven mixing can function without the computer, allowing the 10pre to operate as a portable, stand-alone mixer with effects.

Accessing mixer effects

To access the EQ, compressor or gate for a channel, click its thumbnail at the top of the channel strip (item #3 or 4 on page 47).

MULTI-BAND PARAMETRIC EQ

All input channels and buses provide four bands of center-frequency parametric EQ filtering as shown on page 50. All bands include shelf filtering options.

Enabling EQ bands

Each band has an *enable/disable* button (item #6 on page 50), allowing you to enable as few or as many bands as needed.

EQ filter controls

The EQ filters have three controls (item #7 on page 50):

Control	unit	range
Frequency	Hertz	20 to 20,000
Gain	dB	-20.00 to +20.00
Q (bandwidth)	n/a	0.45 to 10.0

Click a value to edit it numerically. Or drag on it vertically to change it. Or drag its corresponding control handle in the graph above. Controls for each EQ band are color-coded.

EQ filter characteristics

EQ is one of the most widely used processing tools and can be applied to many different situations, from minor corrective tasks to creative tone sculpting. The multi-band EQ has been designed to be flexible enough to cover a broad range of applications. By adjusting Gain and Bandwidth together, you can emulate the smooth and musical character of classic analog EQ circuits.

Filter types

The shelf filter options are similar to those found in most conventional parametric EQs and can be used to filter out low or high frequencies.

GATE



Figure 6-1: The Gate.

To access the gate, click the compressor/gate thumbnail (item #4 on page 47).

The gate silences the signal when the input signal's level drops below the *Threshold*.

The rate at which the gate responds, (opens to let signal through) is determined by the *Attack* parameter. With a short *Attack* time, the gate will open as soon as the signal crosses the *Threshold*; with longer *Attack* times, the gate will gradually open, much like a fade-in.

When the input level falls back below the *Threshold*, the time it takes for the gate to close (how quickly the signal is attenuated), is determined by the *Release* parameter. Short *Release* times will close the gate quickly, abruptly attenuating your signal, versus longer *release* times, which will gradually attenuate your signal, like a natural fade-out.

COMPRESSOR

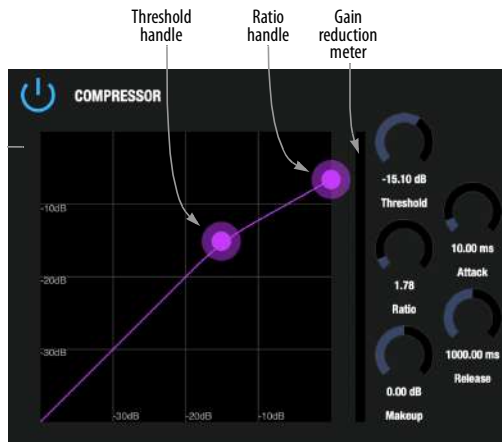

Figure 6-2: The Compressor.

To access the compressor, click the compressor/gate thumbnail (item #4 on page 47).

The *Compressor* lowers the level of the input when amplitude of the signal is above the *Threshold*. The amount of attenuation is determined by the *Ratio* and the input level. For example, if the input is 6 dB above the *Threshold* and the *Ratio* is 3:1, the compressor will attenuate the signal to 2 dB above the *Threshold*. When the input level goes above the threshold, the attenuation is added gradually to reduce distortion. The rate at which the attenuation is added is determined by the *Attack* parameter. Likewise, when the input level falls below the *Threshold*, the attenuation is removed gradually. The rate at which the attenuation is removed is determined by the *Release* parameter. Long *Release* times may cause the audio to drop out briefly when a soft passage follows a loud passage. Short *Release* times may cause the attenuation to “pump”, a term used to describe the sound of the compressor when the average input level quickly fluctuates above and below the *Threshold*. These issues can be addressed by adjusting the parameters. The *Gain reduction meter* (Figure 6-2) displays the attenuation applied by the compressor.

REVERB

To access the reverb settings: scroll to the Reverb bus (item #1 on page 48) and then click the reverb thumbnail, as shown below.

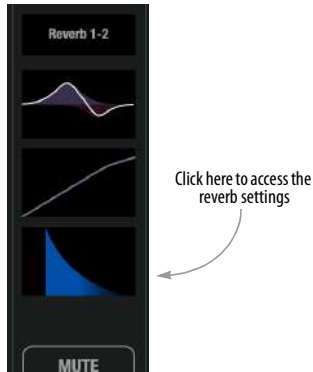

Figure 6-3: Accessing the Reverb processor.

Reverb settings

The Reverb processor (Figure 6-4) provides *Small*, *Medium* and *Large* room sizes, along with *Pre-Delay* (see below), *Damping*, *Decay* (length) and *Width* (stereo image) settings.

Predelay

Predelay is the amount of time before the acoustic energy from the source returns to the listener, after reflecting off the surfaces of the listening space. The very first reflections helps you perceive information about the listening space, (size, distance, surface type, etc.) In large rooms, it takes a while (on the order of milliseconds) before the first reflections return to the listener. Predelay is useful for adding clarity, as it delays these reflections, before the onset of full reverberation. For example, with pre-delay added to vocals, the reflections won't start until after the initial sound of a word has been sung.

Routing inputs to the reverb processor

The reverb processor is a single, independent unit that provides stereo reverb. Use sends to route input signals to it (“Aux Mixing tab” on page 46 and “Mix Sends” on page 52). All incoming signals to the reverb processor are mixed and processed together. The resulting stereo output from the reverb should be routed to a mixer input, where it can be added to the main mix or any aux mix (via sends).



Figure 6-4: The reverb processor.

A/B/C MONITORING

The CueMix Pro Outputs tab (page 42) provides controls for primary, secondary, and auxiliary monitors for your studio, labeled A, B, and C, respectively. For details on how to connect your monitors and set up signal routing to them, see “A/B/C Mode” on page 32.



Figure 6-5: A/B/C monitoring.

Enabling A/B/C monitor mode

To enable or disable A/B/C monitor mode, press the *ABC ON* button (Figure 6-5). When enabled, the output channels in monitor group A, B, and C share the same audio signal (assigned to the channels in group A).

Monitor A/B/C select

To select a monitor pair and mute the other pairs, press A, B or C (Figure 6-5). Press the *ALL* button to hear all three sets of monitors simultaneously.

A/B/C volume control and separate trim

Control the volume of all three monitor pairs with the main volume knob (to the right of the LCD) on the front panel of the 10pre. This knob controls all three monitor pairs. To adjust their volume relative to one another, use their trim controls in the Outputs tab (item #7 on page 42).

TALKBACK

Talkback allows an engineer in the control room to temporarily dim or mute all audio and talk to musicians during a recording session. Talkback requires a microphone located in the control room, near the engineer.



Figure 6-6: talkback settings can be found in the CueMix Pro Home tab.

Talkback setup

To set up talkback:

- 1 Connect a microphone to a preamp and then connect the output of the preamp to any 10pre analog input.
- 2 In CueMix Pro’s Home tab, choose the mic input from the Source menu.
- 3 In the Destinations menu, check the outputs you wish to send the talkback signal to.
- 4 Adjust the Talkback settings as explained below.

Talkback settings

Talkback has the following settings (Figure 6-6).

Talk

Press and hold the *Talk* button (Figure 6-6) to engage the talkback mic.

Latch

When *Latch* is engaged (Figure 6-6), the *Talk* button remains engaged when you click it, until you click it again to disengage, so you don’t have to hold it down while speaking.

Level

Talkback *Level* controls the volume of the talkback signal, as an additional gain stage after the talkback mic preamp gain (and pad, if any).

Dim

If you are feeding a monitor mix to the musicians on the same Aux bus as your talkback mic, use the *Dim* knob (Figure 6-6) to control how much the monitor mix will be attenuated when talkback is engaged. This gives you control over the relative volume between the talkback mic signal and all other audio on the mix bus. To control overall volume of everything, use the bus fader.

Mic effects

Click the *Mic effects* thumbnail (Figure 6-6) for quick access to the EQ, compressor and gate effects for the analog input you are using for talkback. These are the same settings found in the mix tabs for that input (items #3 and 4 on page 47).

THE FACTORY DEFAULT PRESET

To restore the factory default settings for the 10pre:

- 1 Use the front panel MENU knob to navigate to the *Presets* setting.
- 2 Press the SELECT button.
- 3 The right-hand screen should now show the highlighted word *Recall*. Push SELECT again.
- 4 Push SELECT again, choose *Confirm*, and push SELECT to confirm.
- 5 Push BACK repeatedly to back out of the menu.

Factory default settings

The factory default settings (Figure 6-7 on page 58) provide basic operation as an audio interface running on its internal clock at 48 kHz. The patchbay routing is as follows:

SOURCE	DESTINATION(S)
Mic/Inst Inputs 1-10	Host In 1-10 Mixer Ch 9-18
Optical Inputs A 1-8	Host In 17-24
Optical Inputs B 1-8	Host In 25-32
Main Mix	Line Out 1-2
Monitor Mix	Phones 1 L-R Phones 2 L-R
Reverb Mix 1-2	Mixer Ch 19-20
Post FX Out 3-8	Line Out 3-8
AVB Streams 1-12 (8 ch each)	Host In 33-128
Host Out 1-8	Mixer Ch 1-8
Host Out 17-24	Optical Out A 1-8
Host Out 25-32	Optical Out B 1-8
Host Out 33-128	AVB Stream 1-12 (8 ch each)

With this default routing, audio that you play back from your DAW or other host software on *Host Out Ch 1-2* can be heard on *Line Outs 1-2* and the headphone outputs, and all DAW outputs are perfectly time-aligned. In addition:

- In the Mixing tab, if you bring up faders for channels 9-18, you'll add mic/instr inputs to the Line Out 1-2 mix through the 10pre's ultra-low latency on-board mixing.
- Use the EQ on the main mix for simple speaker processing on Line Out 1-2.
- For the other line outputs, simple speaker processing can be achieved by adjusting the EQs on Mixer channels 3-8.
- Apply reverb to any host output or line input by using the *Sends* panel (page 52) to send it to the Reverb 1-2 Mix Bus, and then bring up the *Reverb 1-2* fader in the main mix.

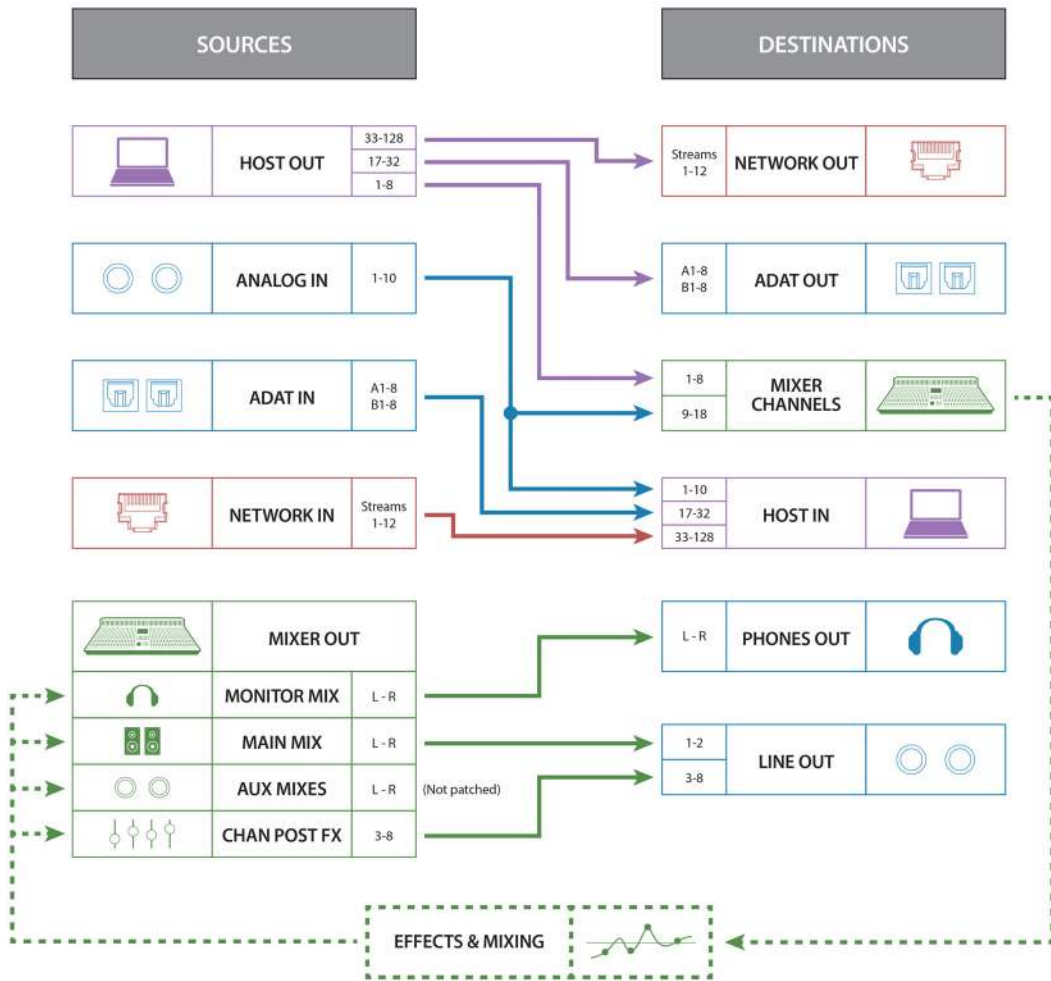

Figure 6-7: The factory default preset provides basic audio interface functionality to and from the host computer, while also incorporating the 10pre's 64-channel mixer.

CUSTOM PRESETS

In the Home tab (page 39), you can save, recall, and erase custom presets in eight preset slots in the device. These controls are also available on the front panel of the device in the Presets menu item.

You can also save and recall an unlimited number of custom presets to your computer or iPad.

All device settings are saved with a preset. Think of the preset as a ‘snapshot’ of all current settings.



Figure 6-8: A Managing custom presets.

To create a custom preset, set up the device as desired, click an empty slot in the list, and then click *Save*. You’ll be asked to name the preset and confirm.

To recall any preset, including the factory default preset, click its name in the list and click *Recall*.

To clear a preset slot, click it in the list and click *Erase*.

To save a preset to your computer or iPad, select it in the list and then click *Save Preset to File*.

To load a preset from your computer or iPad, select a slot in the list and click *Apply Preset From File*.

WORKING WITH OTHER MOTU AVB INTERFACES

If earlier-generation MOTU AVB interfaces are present on the network, they appear in the sidebar. Click on them to access basic settings in the Device tab. Unavailable tabs will be grayed out.

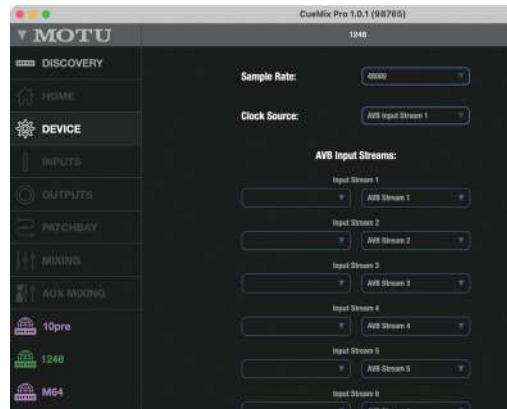

Figure 6-9: A MOTU 1248 selected in the sidebar. Basic network-related settings are available in the Device tab.

FIRMWARE UPDATING

From time to time, MOTU may release firmware updates for the 10pre to improve operation and add new features. To update the firmware:

- 1 Click on your device in the Discovery tab.
- 2 Go to the Device tab and look at the *Firmware* setting (Figure 6-10).
- 3 If your computer has access to the internet, and there is a firmware update available, you’ll see the *Update Now* button (Figure 6-10). Click it to update your firmware.

☛ This step requires that the unit already has firmware version 2.1.5 or later. If not, use the Firmware Updater app (Figure 6-11 on page 60), accessed from the File menu.

☛ As a precaution, turn off your speakers and remove your headphones before clicking the *Update Now* button.



Figure 6-10: Go to the Device tab to see if there is a firmware update available.

4 The 10pre unit will reboot and the screen will display *Update...* A progress bar in CueMix Pro indicates the time remaining. After a minute or so, your device will reboot when the update is complete. It is now ready for operation with all previous settings maintained.

Previous settings and presets are preserved during the firmware update process, so you don't need to worry about saving and restoring settings.

Updating from a firmware image file

You can download a firmware image from motu.com/download and then update your device using the firmware image file. To do so:

- 1 Choose *File menu > Open Firmware Updater* to launch the updater app (Figure 6-11).
- 2 Load the firmware image with the *Choose File* button.
- 3 Once the firmware image is loaded, click the *Update Now* button (Figure 6-11).
- 4 The 10pre unit will reboot and the screen will display *Update...* A progress bar in the Firmware Updater app indicates the time remaining. After a

minute or so, your device will reboot when the update is complete. It is now ready for operation with all previous settings maintained.

Previous settings and presets are preserved during the firmware update process, so you don't need to worry about saving and restoring settings.



Figure 6-11: The 10pre Firmware Updater app.

Updating over Ethernet

A firmware update can be applied to any device over Ethernet, as long as it is available on the same network as your host computer.

Updating over Ethernet requires that the device already has firmware version 2.1.5 or later. If not, connect the device to your computer via USB or Thunderbolt and proceed with the firmware update as described in the previous sections. This only needs to be done once; all future firmware updates for that device can be done over Ethernet.

To update firmware over Ethernet:

- 1 Download the desired firmware image from motu.com/download.
- 2 In CueMix Pro, go to the Discovery tab to confirm that the device you want to update is visible (available on the network).
- 3 On the 10pre front panel, use the MENU knob to navigate to the *Network* menu setting.

- 4 Make note of the unit's IP address.
- 5 Open a web browser on the computer and type in the following URL:
http://[IP address]/update.
- 6 Click *Choose File* to load the firmware image, and then click *Update*.

After a minute or so, your device will reboot when the update is complete. It is now ready for operation with all previous settings maintained.

THE CUEMIX PRO IOS APP

CueMix Pro is also available as an app for iOS and allows you to control the 10pre from your iOS device. Simply download it from the App Store. Also see “iOS setup (USB-C)” on page 20 and “iOS setup (Lightning)” on page 20.

CHAPTER 7 Working with Host Audio Software

The 10pre provides multi-channel audio input and output for Core Audio compatible audio applications on the Mac and ASIO or Wave compatible applications on Windows, including MOTU’s Digital Performer and Performer Lite, Apple’s Logic Pro and GarageBand, and other third-party software applications such as Ableton Live, Avid Pro Tools, Cockos Reaper, Propellerhead Reason, Steinberg Cubase and Nuendo, PreSonus Studio One, Bitwig, and others.

Performer Lite is available as a free download for 10pre owners from their motu.com account page. For complete information about all of Performer Lite’s powerful workstation features, refer to the *Performer Lite User Guide.pdf* found in the Help menu of the Performer Lite application.

Digital Performer, MOTU’s state-of-the-art digital audio workstation software, is available separately; for details about upgrading from Performer Lite to Digital Performer, talk to your authorized MOTU dealer or visit motu.com.

Preparation	62
Run the CueMix Pro app	62
Choose the 10pre.....	63
Channel counts.....	63
Playback from your DAW/host.....	64
Input to your DAW/Host	64
Channel naming.....	64
Reducing monitoring latency.....	65
Loopback.....	67
Working with multiple interfaces	68

PREPARATION

Install your host audio software first if you haven’t already done so, and complete these chapters before proceeding:

- chapter 3, “Software Installation” (page 16)
- chapter 4, “Hardware Installation” (page 19)

RUN THE CUEMIX PRO APP

Before you run your host audio software, launch CueMix Pro to configure your MOTU hardware.

Sample Rate

Choose the desired sample rate for the 10pre (item #4 in the Devices tab on page 40) and your host audio software. Make sure the sample rates for the hardware and software match. Newly recorded audio will have this sample rate.

☛ Optical channels are disabled when the interface is operating at a 176.4 or 192 kHz. In addition, channel counts for host computer I/O and networking are reduced.

Clock Mode

The *Clock Source* setting (item #6 in the Devices tab on page 40) is important because it determines the master digital audio clock for your system.

If you do not have any digital audio connections to your MOTU device (you are using the analog inputs and outputs only), and you will not be resolving your host software to optical or another external clock source, choose *Internal*.

If you have devices connected to the optical ports, see “Choosing a clock source for optical connections” on page 25.

If you are resolving your system to word clock, see “Syncing word clock devices” on page 26.

CHOOSE THE 10PRE

Once you’ve made the preparations described so far in this chapter, you’re ready to run your host audio software and choose the 10pre as your audio interface (“soundcard”).

For macOS audio software

For audio software running under macOS, go to the menu item or preference where you choose the audio device (Core Audio driver) you wish to use, and then select the 10pre by name.

For Windows audio software

For audio software running under Windows, go to the menu item or preference where you choose the ASIO driver you wish to use, and then choose *MOTU 10pre*. If your host audio software doesn’t support ASIO, choose the *10pre Wave* driver instead.

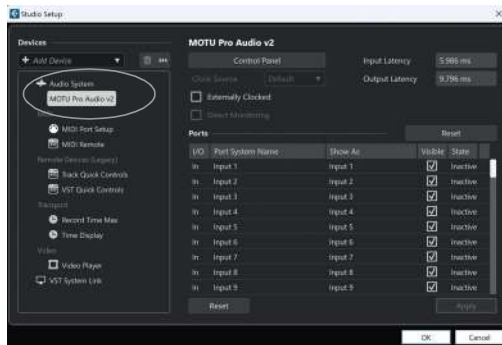

Figure 7-1: Choosing the MOTU Pro Audio ASIO driver in Cubase.

Where to go in popular audio hosts

Here is the location for this setting in various popular audio software host applications:

Host software	Location for choosing the 10pre
Digital Performer and Performer Lite	Setup menu > Configure Audio System > Configure Hardware Driver
Pro Tools	Setup menu > Playback Engine or Current Engine
Logic Pro	Preferences > Audio tab > Devices tab > Core Audio tab
Garage Band	Garage Band menu > Preferences > Audio/MIDI > Audio Output/Input menus
Cubase and Nuendo	Device Setup > Devices list > VST Audio System menu
Live	Preferences > Audio tab
Reason	Preferences > Audio preferences
Reaper	Preferences > Audio prefs > Devices
Studio One Pro	Preferences > Audio Setup

Other audio software

Consult your software’s manual for further information.

CHANNEL COUNTS

Available channels to and from the host computer are as follows, based on sample rate and driver versus USB class compliant operation:

Sample Rate (kHz)	44.1 / 48	88.2 / 96	176.4 / 192
Thunderbolt/USB4	128	128	64
USB3 (driver)	128	64	32
USB3 (class)	128	64	32
USB2 (driver)	64	32	18
USB2 (class)	64	32	18

PLAYBACK FROM YOUR DAW/HOST

For playback from your DAW or other host software, here are the factory default host output channel assignments:

Host Output channel	Destination
Host Out 1-12	Mixer Ch 1-12
Host Out 17-24	Optical Out A 1-8
Host Out 25-32	Optical Out B 1-8
Host Out 33-128	AVB Stream 1-12 (8 ch each)

Note that host output channels 1-12 are routed to the 10pre mixer, which routes them to the 10pre Line Outs 1-2, where you'll hear them on your studio monitors and on the headphone output.

🔊 From the factory, the mixer channel fader for Host Outs 1-2 defaults to unity gain, so you'll hear signal immediately, with no adjustments needed in the mixer. However, the mixer faders for Host Outs 3-4, 5-6, 7-8, 9-10, and 11-12 are set to $-\infty$ by default, so if you want to hear them on your studio monitors, bring up their faders in the Mixing tab (page 45).

Host output channels 17-128 are patched directly to 10pre optical and network output channels, as indicated in the table above.

You can change any of these routings to suit your needs at any time using the Patchbay (page 43) or Routing Grid (page 44).

INPUT TO YOUR DAW/HOST

For input to your DAW or other host software, here are the factory default host input channel assignments:

Host Input channel	Destination
Mic/Line/Inst Inputs 1-10	Host In 1-10 Mixer Ch 9-18
Optical Inputs A 1-8	Host In 17-24
Optical Inputs B 1-8	Host In 25-32
AVB Streams 1-12 (8 ch each)	Host In 33-128

Note that the mic/line/Inst inputs are routed to both your host software and the 10pre's mixer. To hear them on your studio monitors, you can either 1) patch thru from your host software, or 2) bring up their corresponding fader in the Mixing tab (page 45). However, be sure to do only one or the other to avoid unwanted doubling of the signal. The advantage of option 2 is that there will be near-zero latency. Option 1 will create a bit of latency (depending on the buffer size setting) but allows you to mix and process the input with your host software. See "Reducing monitoring latency" on page 65.

CHANNEL NAMING

The names of the 10pre audio channels that you see in your host software can be customized. To do so, go to the Patchbay tab (page 43), click the host icons in the *Sources* and *Destinations* panels, and click the individual host channel names to rename them. Alternatively, you can use the Routing Grid to rename host channels. Simply expand the host banks (source and destination) and click the channel names at the top and side of the grid to rename them.

If both the host channel name and its source or target have a custom name, the host channel name is used. If a host output channel has multiple destinations, you see the phrase *Multiple Destinations* in your host software.

REDUCING MONITORING LATENCY

Monitoring latency is a slight delay caused by running an input signal through your host audio software and back out. For example, you might hear it when you drive a live guitar input signal through an amp modeling plug-in running in your audio sequencer.

This delay is caused by the amount of time it takes for audio to make the entire round trip through your computer, from when it first enters an input on the 10pre, passes through the interface hardware into the computer, through your host audio software, and then back out to an output.

Monitoring through the 10pre

If you don't need to process a live input with plug-ins, the easiest way to avoid monitoring latency is to disable your DAW's live monitoring feature and instead use the digital mixer in the 10pre to route the input directly to your outputs. For details, see "Mixing tab" on page 45. The mixer in the 10pre even provides zero latency effects processing (EQ, compression and reverb), which can be applied to the signal.

Direct hardware playthrough / Direct ASIO monitoring

When managing your live monitor mix through the 10pre mixer, remember to disable your DAW's live monitoring features, so that you won't hear record-enabled tracks in your DAW. Also note that the 10pre does not support *Direct Hardware Playthrough* in Digital Performer, or the *Direct ASIO Monitoring* feature (or similar) offered and other DAWs, which lets you control no-latency hardware monitoring from within the host application. Instead, you can use the CueMix Pro app mixer ("Mixing tab" on page 45) to set up these monitor mixes manually.

If you don't require any effects processing on the input signal (no reverb or compression, for example), all this takes is one click on a fader to route the input being recorded to the output you are using for monitoring.

If you are recording a mono input that you'd like to monitor in stereo, or if you need to apply effects to the monitored signal, you can use the 10pre mixer for that, too. Use the mix tabs and reverb mix (page 45) to apply effects as desired, and perhaps include other channels to the mix.

Monitoring through your host audio software

If you *do* need to process a live input with host software plug-ins, or if you are playing virtual instruments live through your MOTU audio hardware, you can significantly reduce latency by adjusting the audio buffer setting in your host audio software, as explained in the next section.

☛ It is important to note that monitoring delay has no effect on the recording, or playback, of audio data from disk. The actual recording and playback is extremely precise, it is only the monitoring of your live input signal which may be delayed.

Adjusting your host software audio buffer

Buffers are small bundles of audio data. The 10pre "speaks" to your computer in buffers, rather than one sample at a time. The size of these buffers determine how much delay you hear when monitoring live inputs through your audio software: larger buffers produce more delay; smaller buffers produce less.

Adjusting buffer size on macOS

Under macOS, audio I/O buffer size is handled by the host audio application (not by the 10pre Core Audio driver). Most audio software applications provide an adjustable audio buffer setting that lets

you control the amount of delay you'll hear when monitoring live inputs or processing them with software plug-ins. Here are a few examples.

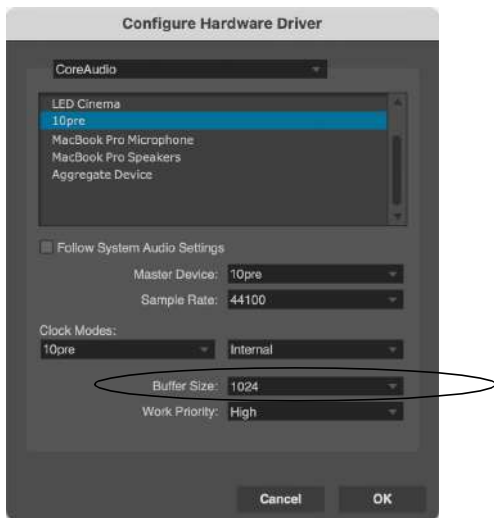

Figure 7-2: In Digital Performer and Performer Lite, choose Setup menu > Configure Audio System > Configure Hardware Driver to open the dialog shown above and access the Buffer Size setting.

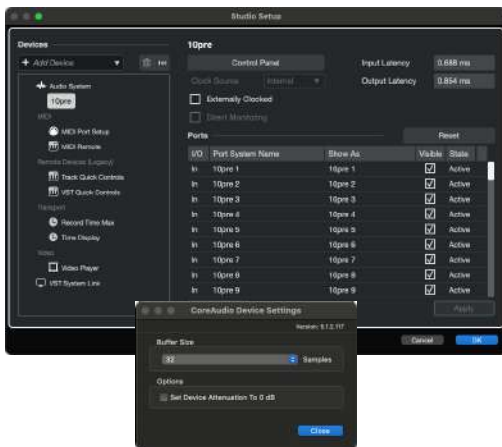

Figure 7-3: In Cubase or Nuendo, choose Devices menu > Device Setup. Select your interface (10pre), then click the Control Panel button to access the window above and the Buffer Size setting.

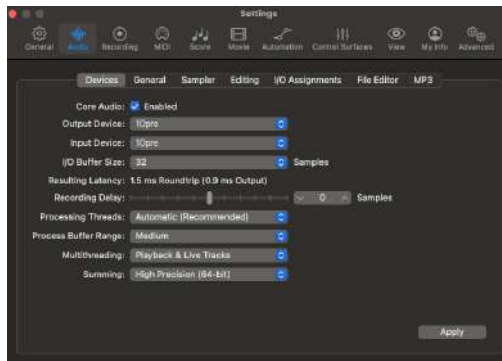

Figure 7-4: In Logic Pro, go to the Audio Driver preferences to access the Buffer Size option shown above.

Adjusting buffer size on Windows

On Windows, the buffer size is adjusted in the CueMix Pro app Device tab (items #9 and 10 in the Devices tab on page 40).

Lower latency versus higher CPU overhead

Buffer size has a large impact on the following:

- Monitoring latency
- The load on your computer's CPU
- Responsiveness of transport controls and effect knobs in Performer Lite, Digital Performer or other audio software.
- Real-time virtual instrument latency.

The buffer setting presents you with a trade-off between the processing power of your computer and the delay of live audio as it is being patched through your software. If you reduce the size, you reduce monitoring latency, but significantly increase the overall processing load on your computer, leaving less CPU bandwidth for things like real-time effects processing. On the other hand, if you increase the buffer size, you reduce the load on your computer, freeing up bandwidth for effects, mixing and other real-time operations.

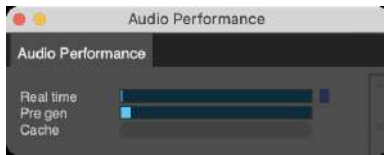

Figure 7-5: When adjusting the buffer size to reduce monitoring latency, watch the ‘Real time’ meter in Digital Performer’s Performance Monitor. If you hear distortion, or if the meter is peaking, try raising the buffer size.

If you are at a point in your recording project where you are not currently working with live, patched-thru material (e.g. you’re not recording vocals), or if you have a way of externally processing inputs, choose a higher buffer size. Depending on your computer’s CPU speed, you might find that settings in the middle work best (256 to 1024).

Transport responsiveness

Buffer size also impacts how quickly your audio software will respond when you begin playback, although not by amounts that are very noticeable. Lowering the buffer size will make your software respond faster; raising the buffer size will make it a little bit slower.

Effects processing and automated mixing

Reducing latency with the buffer size setting has another benefit: it lets you route live inputs through the real-time effects processing and mix automation of your audio software.

LOOPBACK

Loopback is the process of sending audio output from your computer back to the computer so that you can capture the signal in your host software, or stream it live to the web.

Direct loopback in the Patchbay

The simplest way to set up loopback is to route host computer source channels to host computer destination channels directly in the Patchbay, as shown in Figure 7-6. It can be helpful to rename the loopback channels (as shown) for easier identification in your DAW. This method works fine if you don’t need to include other source signal in the loopback channels. Note that you can set up as many loopback channels as needed: you’re not limited to just two.

Using an aux bus for loopback

If you use an aux bus for loopback, you can include additional channels in the loopback mix:

- 1 Choose an aux bus for loopback and make it stereo. See “Bus channel strips” on page 48 and “Input channel settings” on page 49.
- 2 (Optional) Rename the bus *Loopback Aux* or similar for easy identification. See item #5 on page 48 for how to rename a bus.



Figure 7-6: Creating loopback routing in the Patchbay. In this example, Host output channels 1-2 are being routed to Host input channels 31-32.

3 In the Patchbay tab, route any computer output channels you wish to include in the loopback signal to mixer input channels. These computer channels can include audio tracks, virtual instruments, or any other audio output from your audio software.

4 Make sure the input channel faders are up enough to allow plenty of signal.

5 Using sends, route each computer input channel to your loopback aux bus.

6 To include other mixer channels in the Loopback mix, such as live inputs from microphones or instruments connected to the 10pre, do the same for them as well.

7 In the Patchbay tab, route the output of the Loopback bus to any desired computer input channel pair.

The Loopback mix is now routed back to the computer, where it can be recorded, monitored, streamed, etc.

☛ Some podcasting software applications on the market can only see the first 1-2 or 1-4 channels from an audio interface. In this case, the Loopback aux bus will need to be assigned to computer input channels 1-2 or 3-4.

☛ Remember, be careful! When monitoring loopback channels and live inputs, your host software can cause loud feedback loops. Be sure to disable the monitoring of loopback tracks to avoid feedback.

WORKING WITH MULTIPLE INTERFACES

If you have multiple 10pre interfaces (or other AVB equipped interfaces), the best way to use them with your host software is to connect them via AVB to the 10pre unit connected to your computer, as explained in “Connecting multiple 10pre’s to a host” on page 21. The AVB interfaces can then stream audio to and from the host interface, which sends the streams to and from the host computer. This approach provides a great deal of flexibility in how you can physically connect the interfaces, and it provides high channel counts with low latency. See “Setting up the 10pre for networking” on page 74 for further information.

CHAPTER 8 Optical Expander Presets

OVERVIEW

The 10pre has the ability to function as an optical expansion interface. You can connect it to other optical-equipped devices to route the 10pre's analog inputs and outputs to and from the other device. Up to 16 channels are supported at 1x sample rates (44.1 or 48 kHz) and 8 channels at 2x rates (88.2 or 96 kHz).

☛ The Optical Expander factory presets are designed to support the 8-channel ADAT format for both Bank A and B. If you would like to use stereo TOSLink for Bank A input or output, you will need to change the Bank A format manually after choosing an Optical Expander preset, as well as any necessary changes in the Patchbay routing.

Overview	69
Making connections	69
Setting the sample rate	70
Setting the Clock Source	70
Channel mapping at 44.1 or 48 kHz	70

MAKING CONNECTIONS

To route the 10pre's analog inputs to the other device, connect the 10pre Optical OUT A port to the other device's Optical IN port. If the other device has a 2nd bank of optical, connect the 10pre's Optical OUT B to the other device's 2nd Optical IN bank.

To route audio from the other device to the 10pre's line outputs, connect the other device's Optical OUT to the 10pre's Optical IN A port. Similarly, if the other device as a 2nd bank of optical, connect it's 2nd Optical OUT bank to the 10pre's Optical IN B port.

CHOOSING AN OPTICAL EXPANDER PRESET

Before you choose an optical expander preset, you may wish to save the current state of hardware, so you can return to it later. To do so, turn the MENU knob on the front panel and choose *Presets*. Then use the SELECT button and MENU knob to save to an empty preset slot. Use the BACK button to return to the meter screen when you are finished.

To choose an optical expander preset, turn the MENU knob and choose *Optical Expander Presets*. Then use the SELECT button and MENU knob to select the optical expander preset that matches the sample rate you wish to work at:

- 44.1 kHz Preset
- 48 kHz Preset
- 88.2 kHz Preset
- 96 kHz Preset

Optical expander preset settings

The *Optical Expander* presets leave most of the 10pre settings unaffected, including basic device settings, mixing, effects, etc. They do affect settings that are directly relevant to optical expansion, as follows:

- All analog inputs are patched directly to both optical output banks.
- Both optical input banks are patched directly to line outputs.
- All analog input gain and output trim settings are zeroed out (no gain or trim).
- All line outputs are assigned to the Monitor Group, such that all line outputs can be controlled with the main volume knob.

SETTING THE SAMPLE RATE

In the CueMix Pro Device tab, be sure that the sample rate setting (item #4 on page 40) for the 10pre matches both the preset you chose and the sample rate of the other device. At the 1x sample rates (44.1 and 48 kHz), each optical bank provides 8 channels. At the 2x rates (88.2 and 96 kHz), each bank provides 4 channels.

SETTING THE CLOCK SOURCE

When operating as an Optical Expander, the 10pre transfers digital audio channels over its optical connections. It is therefore crucial to make sure that the clocks in the two devices are properly resolved. See the following sections for further information:

- “Synchronization” on page 25
- “Syncing optical devices” on page 26

CHANNEL MAPPING AT 44.1 OR 48 KHZ

At 1x sample rates, the 10pre’s two optical banks are mapped as follows:

Optical Input	Destination
Bank A Inputs 1-8	Line Outputs 1-8
Bank B Inputs 1-8	- none -

Source	Optical Output
Analog Inputs 1-8	Bank A Outputs 1-8
Analog Inputs 9-10	Bank B Outputs 1-2

CHANNEL MAPPING AT 88.2 OR 96 KHZ

At 2x sample rates, the 10pre’s two optical banks are mapped as follows:

Optical Input	Destination
Bank A Inputs 1-4	Line Outputs 1-4
Bank B Inputs 1-4	Line Outputs 5-8

Source	Optical Output
Analog Inputs 1-4	Bank A Outputs 1-4
Analog Inputs 5-8	Bank B Outputs 1-4

CHAPTER 9 Networking

OVERVIEW

The Audio Video Bridging (AVB) network ports on your MOTU interface open up a world of possibilities for creating expanded, customized audio network systems.

Overview	71
About AVB	71
MOTU's AVB implementation.....	72
Networking examples	72
A quick guide to networking.....	73
Setting up the 10pre for networking.....	74
Routing audio to/from network streams.....	77
Mapping computer channels to network streams.....	78
Device presets and AVB stream connections.....	78

ABOUT AVB

Audio Video Bridging (AVB) is an extension of the Ethernet networking standard developed by the IEEE (1722.1 standards committee) specifically engineered for high-performance audio and video networking.

☛ You may also hear AVB referred to as *AVB/TSN* or simply *TSN* because AVB is based on a set of timing protocols referred to as *Time Sensitive Networking*.

The pro audio industry has seen many network-related protocols come and go over the years, but AVB has emerged as a widely-adopted open standard that brings together the worlds of networking technology and high-end audio. Here is a brief summary of some of the immediate benefits of AVB for you, as a MOTU AVB interface user:

- **An open industry standard** — AVB has been developed by the IEEE as an international standard specification, like AES/EBU and other similar IEEE-driven protocols. It is not proprietary or controlled by one company.
- **High channel counts** — AVB provides hundreds of network channels.
- **Extremely low, predictable latency** — AVB guarantees very low-latency real-time performance.
- **Guaranteed Quality of Service** — AVB's Stream Reservation Protocol provides guaranteed Quality of Service (QoS) for each and every audio stream. If the network cannot continuously maintain every bit of every sample in the audio stream, it will not allow you to make the network connection in the first place. AVB streams are prioritized over other network traffic to ensure high performance.
- **Network-wide clocking and sync** — AVB devices all clock together over your network for better-than-sample-accurate phase lock across all connected devices. Timing accuracy is down to the nanosecond.
- **Plug-and-play operation** — AVB has been designed from the ground up to provide automatic device discovery, enumeration, and connection management. Just plug your MOTU AVB interfaces into a standard AVB switch and go. If you wish to make stream connections and have the ability to select media clock, you must use the CueMix Pro app, or some other AVB controller. You don't need an IT professional to configure the network. AVB is a self-managing network protocol.

- **Shared operation with standard Ethernet** — AVB cooperates with standard Ethernet traffic on the network, so you can use traditional Ethernet devices like wireless routers, switches, or any other non-AVB-aware device on the same AVB network as your AVB devices.
- **Support for existing network infrastructure** — Replace your existing switches with standard AVB-compatible switches, and your CAT-5e or CAT-6 wired infrastructure now supports AVB.
- **Long cable runs** — A single AVB network connection can run up to 100 meters with a standard copper wire CAT-5e or CAT-6 cable. Fiber-optic cable runs can be much longer. With daisy-chains and multiple switches, you can create a network that covers very large distances, if necessary. You can connect up to seven “hops” (device-to-device connections).

MOTU'S AVB IMPLEMENTATION

MOTU engineering has faithfully implemented the IEEE AVB standard for MOTU AVB products. This means that MOTU devices are inter operable with compliant 3rd party AVB-compatible devices. This includes current IEEE 1722.1 compatible devices, earlier-generation MOTU AVB devices, and 3rd-party devices that support the legacy AM8-24 Stream Format.

In addition, MOTU has fine-tuned AVB operation among MOTU AVB devices for optimum performance, within the AVB specification. Here is a brief summary of advantages you will enjoy when using MOTU AVB devices together in a network:

- **Up to 256 channels of host I/O** — MOTU AVB interfaces (depending on the model) can support up to 256 simultaneous channels of audio I/O (128 in, 128 out) to and from the entire network through Thunderbolt or USB3.

- **Support for multiple computer hosts** — All computers and all network devices run in sync with each other, resolved to the network's master clock.
- **Gigabit Ethernet** — The MOTU AVB Switch delivers 1 Gbit Ethernet performance, which provides substantially higher bandwidth than 100 Mbit Ethernet. This allows you to have many more devices on the AVB network.
- **Over 600 channels of network audio** — A gigabit AVB network can stream over 600 channels of audio throughout the network (at 1x sample rates). The 10pre can simultaneously broadcast and listen to 128 audio channels across 32 AVB streams.
- **Very low network latency** — Network latency is the time it takes for a data packet (such as an audio sample) to be transmitted over the network. Standard AVB network latency is 2 milliseconds (ms).
- **Flexible network topology** — MOTU AVB supports both daisy-chaining and hierarchical tree structures for maximum flexibility.
- **Cross-platform app** — MOTU AVB devices can be controlled from the CueMix Pro app, which runs on macOS, Windows and iOS.
- **MOTU AVB Switch** — The affordable six-port MOTU AVB Switch provides economical AVB networking for a wide range of small to medium sized AVB networks.

NETWORKING EXAMPLES

Here are just a few examples of what is possible.

Personal studio expansion

Let's say you have an 10pre mounted in a rack next to your computer. You could add an 8M interface and position it across the room, near your drum kit, for placing up to 8 mics on the drums. All the mic cabling is kept near the drums, and you have one simple, clean network cable running back to

your computer system. Despite the distance, the two interfaces operate as a seamless system, controlled from your computer or iPad.

Studio installation

Networking is ideal for studio installation because you can position interfaces at strategic locations. Running cables becomes much simpler and more cost effective. Not only does a setup like this give you access to all I/O from your computer, even multiple computers, you can also route audio from any input to any output across devices with near zero latency. You can also route audio from one computer to another with very low latency. As a simple example, you could deploy several interfaces across multiple rooms in a recording studio.

Large studio facility

In a large studio facility, you could build audio network neighborhoods similar to the studio installation described earlier in multiple rooms, even multiple floors, with multiple computers and Wi-Fi control from anywhere in the facility. All computers and devices can see each other and you can stream audio anywhere on the network with near-zero latency, as if any two devices were connected directly to each other.

Concert systems

Concert systems must be flexible so they can adapt to each new venue while on tour. Because of its modular nature, AVB networking allows you to design systems that are scalable and easy to adapt to each venue. You can easily bring devices on and off line, rerouting audio stems as needed.

By connecting multiple computers to the network, you can set up backup playback systems on the network. For example, in a concert setting, if one computer system goes down, the backup system can be brought on line instantly through the same network infrastructure.

Traditionally, live performance setups often have separate domains for front of house mixing, monitor mixing, computer backline, and other systems. With MOTU AVB networking, these systems can be unified on the same network, opening up many possibilities for shared resources and mixing/routing responsibilities, especially from multiple sources (laptops, iPads, tablets, etc.) MOTU AVB's very low latency makes it particularly suitable for line arrays and sound reinforcement.

Large-scale venues

With long cable runs and industry standard networking infrastructure, MOTU AVB systems are well-suited for large-scale commercial installations such as arenas, stadiums, theme parks, clubs, casinos, houses of worship, broadcast facilities, schools, universities, and so on. Audio streams can travel long distances with sub-millisecond latency through as many as seven switches. Audio can be distributed from a centralized location to anywhere in the venue.

A QUICK GUIDE TO NETWORKING

MOTU AVB networking has been designed to be powerful, yet straightforward to set up and use. Here are a few things that are useful to know.

Networking basics

- To make network connections, use CAT-5e or CAT-6 cables (a higher grade cable). They are available wherever network cables are sold.



- Network cable lengths can be long: 100 meters with standard copper wire cables; much longer with fiber-optic network cables.

Working with AVB switches

- If you have MOTU AVB interfaces that are equipped with two network ports on them, you can daisy-chain up to eight devices in a single chain (with a total of seven connections in the chain).
- For larger networks, use an AVB-compatible switch. You can use any standard AVB switch on the market. MOTU offers the six-port MOTU AVB Switch™ (sold separately).
- ☛ A non-AVB compatible switch will not work.
- Connect MOTU AVB interfaces to any AVB Switch using their NETWORK ports.
- You can also connect a Wi-Fi router, your Local Area Network (LAN), and/or your computer.
- Expand the network by adding more switches. Make a single connection from one switch to the other.
- You can daisy-chain devices and switches in serial fashion, but don't create loops. For example, in the network shown below, do not make any additional connections between any two switches.

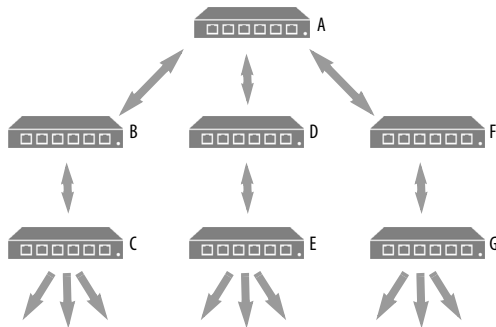

Figure 9-1: Use a hierarchical tree structure, as shown in this example. Be sure there is only one connection between any two devices on the network.

- AVB audio may not pass reliably through more than seven switches, so plan your network topology accordingly to avoid this.

Working with computers on a network

- Computers are not required for network operation, as you can control the network from iPads, tablets and smart phones.
- To add computers to the network, connect them to any interface using Thunderbolt (which offers the highest possible channel counts). If Thunderbolt is not available, use USB.
- A computer can be connected to the network through its Ethernet port, but only for the purposes of running the CueMix Pro app on the computer for command and control over the network. (In this scenario, you won't be able to stream audio to/from the network from the computer.)
- All computers and interfaces on the network have full access to each other.
- MOTU employs a 1 Gbit AVB implementation in the MOTU AVB Switch and 10pre, allowing both devices to route many audio channels on the network.

SETTING UP THE 10PRE FOR NETWORKING

Once the 10pre is connected to other AVB devices, either directly or via an AVB switch, using network cables as described earlier in this chapter, the 10pre can stream audio to and from the other devices on the network.

The 10pre supports sixteen AVB input streams and sixteen output streams. Each stream can be independently configured for one to eight audio channels.

10pre input streams are used to receive streams broadcast by other connected AVB devices (*talkers*).

Conversely, 10pre output streams broadcast to other AVB devices (*listeners*).

The 10pre automatically “sees” the other connected AVB devices and allows you to make stream connections to and from them. Streams must be connected for audio to pass between the 10pre and the other devices.

Connecting an input stream

To connect an 10pre input stream to a stream from another device:

- 1 In the CueMix Pro app, go to the Device tab (page 40).
- 2 Choose any Input stream (it doesn’t matter which one) and use the *Source Device* and *Source Stream* menus to specify the device and stream you wish to connect it to.

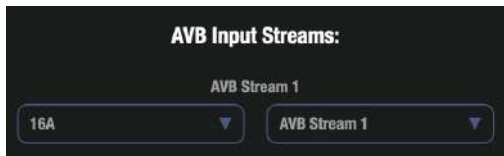

Figure 9-2: Connecting an input stream.

The input stream can now receive signal on audio channels from the other device.

☛ When connecting an input stream, the source device determines the number of audio channels in the stream and CueMix Pro will display the source channels accordingly in the Patchbay tab.

Connecting an output stream

To connect an 10pre output stream to another device:

- 1 In the CueMix Pro app, go to the Device tab (page 40).
- 2 Choose any Output stream (it doesn’t matter which one) and use the *Channels* and *Format* menus to specify the number of channels in the stream and its AVB stream format (see “AVB output stream format” below).



Figure 9-3: Connecting an output stream.

- 3 Click on the other device in the CueMix Pro sidebar to access its settings (item #12 on page 38).
 - 4 Connect one of the device’s input streams to the 10pre output stream.
- ☛ Most AVB devices should display basic device and stream settings in CueMix Pro. In some cases, this may not be the case. If so, you will need to access the device’s settings through the device itself, or its control software.

AVB output stream format

Since AVB was first developed, stream formats have evolved. *AM8-24* is an older format supported by earlier-generation MOTU AVB devices (such as the 1248, 8M, original 10pre, etc.) and other 3rd-party AVB gear. *AAF-PCM* is a newer format that is supported by many Milan-compatible AVB devices. Below is a summary of which format to use in various situations.

Destination AVB device (listener)	10pre output stream format to use
10pre (2025)	AAF-PCM or AM8-24 (either works fine)
8M (2014)	AM8-24
Earlier-generation MOTU AVB interfaces	AM8-24
Older 3rd-party AVB devices	AM8-24
Both new and earlier MOTU AVB devices	AM8-24
Milan-compatible AVB devices	AAF-PCM

If you are not sure which format to choose, experiment with both until audio passes successfully between devices.

If you are sending a stream to both new and earlier-generation MOTU interfaces, use AM8-24. If you need to send the same audio signal to separate devices that don't support the same format, create two separate streams (for each format) and patch the audio signal to both streams (using the Patchbay).

Syncing AVB devices

When connecting AVB streams between two or more devices on a network, one device needs to be designated as the media clock reference, which all other devices will follow as a clock source.

To do so, first choose a reference device and set its Clock Source to *Internal*, or any other clock source besides an AVB network stream. If it is an 10pre, or any other MOTU AVB interface (including earlier generation MOTU AVB interfaces), now go to the Device tab in CueMix Pro and click the *Become AVB Media Clock Reference* button. Now, all other MOTU devices on the network will resolve to its clock.

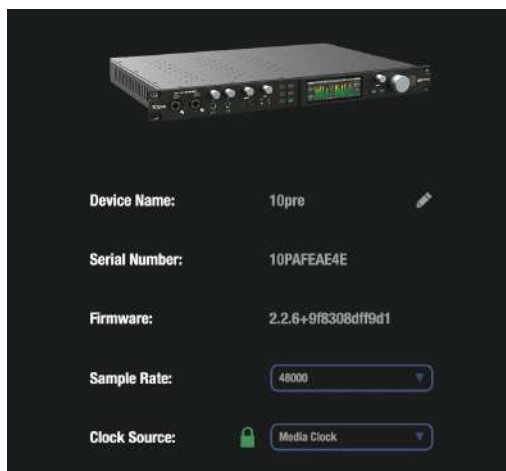

Figure 9-4: In this example, the 10pre is resolving to the media clock of another MOTU device that has been designated as the media clock reference. (The Media Clock input stream of the 10pre is connected to the media clock reference device.)

Earlier-generation MOTU AVB interfaces require firmware version 1.4.7+99954 or later to support the new 10pre's *Become AVB Media Clock Reference* button, or conversely, for the new 10pre to respond to their *Become Clock Master* button.

Resolving 3rd-party AVB devices to the 10pre

To resolve a 3rd-party AVB device to the 10pre, use an AVB stream as follows:

- 1 For the 10pre (connected to your computer), go to the CueMix Pro Device tab and set its Clock Source to *Internal* (or any other clock source besides an AVB network stream).
 - 2 Scroll to the bottom of the 10pre Device tab to the *Media Clock* output stream setting and choose a format that is compatible with the 3rd-party device. If the 3rd-party device supports Milan, choose the *CRF Audio 96/1* format. The other format (*AM8-24*) may also work for some devices. Try it if the CRF format doesn't seem to work.
 - 3 For the 3rd-party AVB device, click its icon in the CueMix sidebar (item #12 on page 38) to access its settings.
 - 4 Go to the Device tab. In the *AVB Input Streams* section choose the 10pre as a source device for one of the streams and choose *Media Clock* for its *Source Stream* (Figure 9-2 on page 75), if compatible. If not, choose any available input stream from the menu.
- Be sure to set the 10pre format for the chosen stream to a format that is compatible with the other device. See "AVB output stream format" on page 75.
- 5 In the Device tab *Clock Source* menu for the other device, choose the AVB Input Stream you used above. Doing so resolves the other device to the 10pre via their AVB stream connection.



Figure 9-5: Using the 10pre's Media Clock Stream as a clock source for another AVB device.

Resolving the 10pre to a 3rd-party AVB device

The procedure for resolving the 10pre to a 3rd-party AVB device is similar to the procedure described in the previous section, except in reverse: set the 3rd-party device's clock source to *Internal* (or any other clock source besides an AVB network stream), and then in the 10pre Device tab, set up an input stream from the other device and then use that stream as the 10pre's clock source.

Making stream connections in the Patchbay

You can make stream connections in the Patchbay tab (page 43). Input streams are shown in the network SOURCES bank on the left; output streams are shown in the network DESTINATIONS bank on the right. Click the disclosure triangle for a stream to access the stream settings. These are the same settings as the Device tab, as described in the previous sections.

Clock source freewheeling

When resolving the 10pre to the media clock of another device on an AVB network, you may see the freewheeling clock icon, as shown below.

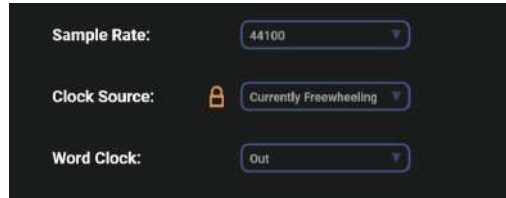

Figure 9-6: Freewheeling mode.

The 10pre enters freewheeling mode when it temporarily loses the network media clock reference, switches grandmaster clocks, or links up a network port. In this case, the 10pre continues to run at the clock rate last received from the network media clock, with no disruption to any audio streams being passed to/from the device, until the network media clock is regained by the 10pre. Momentary disruptions like this can happen in various situations, such as when devices are added to, or removed from, the network. In most cases, you'll experience no disruption in audio streaming performance during freewheeling.

Freewheeling is momentary and should only occur for a few seconds. (Up to 30 seconds can be considered normal during network topology changes.) If you see the freewheeling icon continuously for long periods of time, check your clock settings, as this indicates that they may need to be reconfigured.

ROUTING AUDIO TO/FROM NETWORK STREAMS

Once you've made stream connections, as explained in the previous sections, use the Patchbay tab (page 43) or Routing tab (page 44) to map input streams to destinations and to choose source audio channels for output streams.

Routing input streams in the Patchbay

In the Patchbay, input streams (coming from other devices) are shown in the network SOURCES bank on the left. Expand the stream to view its channels and use the patchbay to connect those

stream channels to any desired destination channel in the right-hand bank. Possible destinations include the computer, the 10pre mixer, physical 10pre outputs (analog or optical), and even output AVB streams.

Choosing source audio channels for output streams in the Patchbay

10pre output streams being broadcast to other AVB devices are listed in the DESTINATIONS bank on the right of the Patchbay. Expand the stream to view its channels and use the patchbay to connect source audio channels to the stream's audio channels. Possible sources include 10pre physical inputs (analog and optical), computer output channels, 10pre mixer bus outputs, and even input AVB streams. You can also specify the number of channels in the stream, and the stream format (explained earlier).

Routing audio to/from network streams in the Routing tab

AVB input streams (which bring in audio channels from other devices on the network) are shown as Sources across the top of the grid. Expand an AVB stream bank to show its individual channels. Use the grid to connect those channels to any desired destination channel (row) along the right side of the grid (or the left side of the grid, if you are displaying destinations on the left).

AVB output streams (which broadcast 10pre audio channels to the rest of the network) are shown as destinations along the right side of the grid (or the left side of the grid, if you are displaying destinations on the left). Expand an AVB stream bank to show its individual channels. Use the grid to connect those channels to any desired source channel (column) across the top of the grid.

MAPPING COMPUTER CHANNELS TO NETWORK STREAMS

If a host computer is connected to an interface (through Thunderbolt or USB), mapping network input and output streams is accomplished as described in the previous two sections. Simply enable AVB streams as desired, and map them to computer channels in the Patchbay tab.

DEVICE PRESETS AND AVB STREAM CONNECTIONS

When you save an 10pre preset, any AVB stream connections that it has established with other devices on the network are included with the saved preset. When you recall the preset, those saved stream connections are restored, as long as the other devices are still present on the network and broadcasting (and listening to) the same streams as when the preset was saved. If the other device is not present (or perhaps turned off), its streams will be reported as *offline*.

In general, if you have multiple devices on a network with interconnecting AVB streams, and you wish to preserve the state of the network, it is recommended that you save a device preset for each device on the network. Doing so will allow you to faithfully restore the entire network stream configuration by recalling each device's saved preset.

Part 3

Appendices

APPENDIX A Troubleshooting

My 10pre isn't showing up in Audio MIDI Setup on my Mac.

Due to the updated architecture of macOS Catalina (10.15) and above, the system extensions for all newly-installed third-party software will automatically be blocked from running. If your 10pre is not showing up in Audio MIDI Setup, CueMix Pro or your DAW, you might need to enable the driver in your System Preferences. To do so, first download and install the very latest installer for your 10pre. After restarting, open System Preferences. Select Security & Privacy. In the General section, click the Allow button. The Allow button will disappear 30 minutes after installation. If the button has disappeared, run the installer for the MOTU driver again.

I have absolutely no audio input or output happening to or from my 10pre. Why?

Make sure that the unit has a stable sample rate (the *lock icon* in the front panel display will turn red if the clock hasn't settled yet). Try setting the unit's clock source to *Internal* if you can't sync to any external clock sources. Check that audio is working with Internal sync, and if so, then work on establishing a stable external clock.

I can't hear computer audio output through my 10pre.

In the Sound panel of System Preferences, the 10pre should be selected as the output device.

How do I monitor live inputs?

Please refer to the documentation for the audio application that you are using. If your application does not support input monitoring, you will need to use the mixer in the 10pre. Please see "Monitoring through the 10pre" on page 65.

How do I control monitoring latency?

See "Reducing monitoring latency" on page 65.

How do I factory reset my device?

Push SELECT or turn the MENU knob to enter the main menu. Navigate to *RESET* and tap the SELECT button three times to reset.

I hear clicks and pops under optical or S/PDIF sync.

Many problems result from incorrect sync settings. See "Synchronization" on page 25. Whenever there is any unexpected noise or distortion, suspect digital clocking issues.

Connecting or powering gear during operation...

It is not recommended that you connect/disconnect, or power cycle connected devices while recording or playing back audio. Doing so may cause a brief glitch in the audio.

CUSTOMER SUPPORT

We are happy to provide complimentary customer support to our registered users. If you haven't already done so, please take a moment to register online at MOTU.com. Doing so entitles you to technical support and notices about new products and software updates.

TECHNICAL SUPPORT

If you are unable, with your dealer's help, to solve problems you encounter with your MOTU device, you may contact our technical support department in one of the following ways at motu.com/support:

- Live Chat: You can connect directly with a technician Monday through Friday between 10 AM and 5 PM Eastern Time.
- Schedule a call: You can schedule a callback time to speak with a technician by phone Monday through Friday between 1 PM - 5 PM Eastern time.

- Support ticket: You can submit an online support ticket at any time, 24 hours a day, 7 days a week. A technician will get back to you in 1-2 business days.

Please provide the following information to help us solve your problem as quickly as possible:

- The serial number of your MOTU device. This is printed on a label placed on the bottom of the unit and on the side of the box. You must be able to supply this number to receive technical support.
- A brief explanation of the problem, including the exact sequence of actions which cause it, and the contents of any error messages which appear on the screen.
- The pages in the manual that refer to the features or operation of your MOTU Device or Performer Lite with which you are having trouble.
- The version of your computer's operating system.

We're not able to solve every problem immediately, but a quick support ticket or chat may yield a suggestion for a problem which you might otherwise spend hours trying to track down.

If you have features or ideas you would like to see implemented, we'd like to hear from you. Please write to the Development Team, MOTU Inc., 1280 Massachusetts Avenue, Cambridge, MA 02138, or use our online suggestion box at www.motu.com/suggestions.

APPENDIX B Audio Specifications

MIC in

Connector Type	Combo-style, XLR / TRS	Pin 2 hot, tip hot
----------------	------------------------	--------------------

XLR

Impedance load	2.8 k ohm	
Pad	-20 dB, Switchable per channel	
Phantom power	+48V, switchable per channel	DIN 45596 / IEC 61938-P48
EIN	-129 dBu	A-weighted, 20-20k, 150 ohm
Dynamic Range	118 dB	A-weighted
THD+N	-114 dB	1kHz, -1dBu, 0dB gain, unweighted
Frequency Response	+0.05 / -0.1 dB, 26 Hz-20 kHz	Ref. 1 kHz
Max Level In with Pad	+21.5 dBu	
Max Level In without Pad	0.5 dBu	
Gain range	0 to +74 dB in 1 dB steps	

TRS

Description	Balanced or single ended	Suitable for line or instrument (guitar)
Impedance Load	1 meg ohm 2 meg ohm	unbalanced balanced
Pad	None	
Phantom power	None	
Dynamic Range	115 dB	A-weighted
THD+N	-109 dB	1kHz, 17 dBu, 0dB gain, unweighted
Frequency Response	+0.05/-0.6 dB, 40-20kHz	Ref. 1 kHz
Max Level	+20 dBu Differential, 18dBu Single-ended	Balanced; +18 dBu unbalanced
Gain range	0 to +74 dB in 1 dB steps	

Line Out

Connector Type	1/4" Female, TRS	Balanced, tip hot
Output Impedance	220 ohm	Per leg
Dynamic Range	125 dB	A-weighted
THD+N	-114 dB	-1 dBFS, Unweighted, 1 kHz
Frequency Response	+0.01/-0.15 dB, 20 Hz-20 kHz	Ref. 1 kHz
Max Level Out	+21 dBu	
Trim Range	0 to -99 or -∞	Digitally controlled in 1 dB steps

Phones

Connector Type	1/4" Female, TRS Stereo	Tip Left, Ring Right
Output Impedance	< 1 ohm	
Dynamic Range	118 dB	
THD+N	-110 dB	Unweighted, -1 dBFS, 1 kHz
Frequency Response	+0.01/-0.1 dB, 22 Hz-20 kHz	Ref. 1 kHz
Trim Range	0 to -99 dB, plus mute	0 to -99 dB in 1 dB steps
Max output	13.3 dBu	Unloaded

Word Clock In/Out/Thru

Specification	AES-11 2009 Annex B	
Connector Type	BNC	
Termination	75 ohm (in/out)	THRU is unterminated
Lock Range	44.1 kHz / 48kHz, +- 0.5%	x1/x2/x4
Input	1 vpp to 3 v p-p (with termination)	AC coupled
Output	5.0 vpp, (2.5 v p-p terminated)	DC coupled
Jitter	complies with AES3-4-2009	< 0.025 UI

Power Supply

Connector Type	IEC 3-conductor receptacle	For AC mains connection
Configuration	Internal, Universal	
Power Input	100 V to 240 V, 50 Hz or 60 Hz	
Power Usage	1.0A max (peak draw)	

- +4dB analog input 22
 - 10dB analog input 22
 - 10pre
 - ASIO driver 63
 - connecting multiple units 21
 - naming 40
 - presets 35
 - renaming 38
 - setup example 8
 - specifications 82
 - summary of features 11
 - 24-bit
 - optical 10, 12, 25
 - 2x SMUX mode 25
 - 40 Gbps USB cable (included) 15, 19
 - 4-band EQ 50, 53
 - 5.1/7.1 surround monitoring 9, 10, 32, 42
- A**
- A/B monitoring 32
 - A/B/C monitoring 24, 42, 56
 - AAF-PCM stream format 75
 - AB ON button 9
 - Ableton Live 62, 63
 - ADAT optical 10, 12, 25
 - connecting 25
 - input format 41
 - output format 42
 - ADCs 11
 - Advanced (front panel menu) 31
 - AM8-24 stream format 75
 - Analog conversion 11
 - Analog inputs 10
 - boosting gain 23
 - Analog outputs 10
 - trimming 23
 - Apple
 - GarageBand 63
 - Logic Pro 63
 - Apply Preset From File 59
 - ASIO
 - driver 63
 - monitoring 65
 - Attack
 - Compressor 54
 - Gate 54
 - Auto setting 45
 - Aux bus
 - channel strip 48
 - fader 46
 - Aux Buses 45
 - Aux Mixing tab (CueMix Pro) 46
 - AVB
 - connections 74
 - device list 38
 - Ethernet explained 71
 - input stream setup 75
 - input streams 40
 - networking 71-78
 - output stream setup 75
 - output streams 40
 - overview 71
 - routing audio to/from 77
 - setup 74
 - stream format 75
 - switch 22
 - switches 74
 - syncing AVB devices 76
 - Avid Pro Tools 63
- B**
- Back button 9
 - Become AVB Media Clock Reference 40, 76
 - Buffer Size 18, 40
 - Bus power 19
- C**
- Calibration (analog I/O) 23
 - CAT-5e/6 cables 73
 - Channel Strip 49
 - Clear Solo 48
 - Clock section (front panel display) 30
 - Clock source 25, 40
 - Cockos Reaper 63
 - Compressor 47, 48, 49, 51, 54
 - Condenser mic input 22
 - Connections (Routing grid) 44
 - Core Audio driver 63
 - CRF Audio 96/1 stream format 76
 - Cubase 62, 63
 - clock source 62
 - sample rate 62
 - CueMix Pro 18, 37-61
 - app 61
 - Aux Mixing tab 46
 - Device tab 40
 - Discovery tab 38
 - dmg virtual disk image 7, 16
 - Home tab 39
 - input channel settings 47, 49
 - Input channel strips 47
 - Inputs tab 41
 - iOS app 61
 - Mixing tab 45
 - Outputs tab 42
 - Patchbay tab 43, 44
 - Routing tab 44
 - saving/recalling presets 35
 - sidebar 38
 - Customer support 80
- D**
- DAC filter 31, 35
 - DACs 11
 - Damping (reverb) 55
 - DAW
 - input/recording 64
 - playback 64
 - Decay (reverb) 55
 - Default Preset 35
 - Destinations bank (Patchbay) 43
- Device Name** 40
- Device tab** 40
- Clock source 40
 - Device presets 35
 - Host buffer size 40
 - Output Safety Offset 18, 40
 - Sample rate 40
 - Serial number 40
 - WDM Input/Output Streams 40
 - word clock 40
- Digital Performer 62, 63
- Direct hardware playthru 65
- Dim 34
- Dim (talkback) 57
- Direct ASIO monitoring 65
- Direct hardware playthru 65
- Disconnect button 38
- Discovery tab 38
- Display setting 31
- Driver
 - installation 7, 16, 17, 37, 38
 - loopback channels 67
- DSP 12
 - effects 53
 - processing 53
- Dynamic mic 22
- Dynamics processing 47, 48, 49, 51
- Compressor 54
 - Gate 54
- E**
- Effects 53
 - EQ 47, 48, 49, 50, 53
 - enabling 53
 - filter types 53
 - frequency 53
 - gain 53
 - Q 53
 - Equipment rack installation 7
- F**
- Factory preset 31, 57
 - Firmware
 - updating 40, 59
 - version 31, 40
 - Follow menu (Monitor bus) 48
 - Frequency
 - EQ 50, 53
 - Front Panel
 - lockout 35
 - Front panel 29
 - Back button 9
 - display 13
 - Headphones section 9
 - Host status indicator 9, 30
 - Inputs section 9
 - lockout 31
 - Menu knob 9
 - metering 29
 - Monitor section 9, 29
 - Network status icons 9, 30
 - Select button 9

- Volume knob 9
- Front panel display
 - menu 30
 - menu navigation 30

G

- Gain
 - EQ 50, 53
 - reduction 54
- GarageBand 62, 63
 - clock source 62
 - sample rate 62
- Gate 47, 48, 49, 51, 54
- GR (gain reduction) 54
- Guitar
 - connecting 22

H

- Headphone outputs 9, 10
- Headphones 13
 - connecting 8, 9
 - source 42
 - volume 9, 31, 39
 - volume control from computer 42
- High-Pass Filter 49
- Home tab 39
- Host banks (Patchbay) 43
- Host computer
 - Buffer Size 18, 40
 - channel naming 64
 - connecting multiple 848s 21
 - connection 19
 - icon 30
 - input/recording 64
 - loopback 67
 - playback 64
 - port 10
 - status indicator (CueMix Pro) 38
- Host status indicator (front panel display) 9, 30
- HPF 49

I

- IEEE 802.1 71
- Input channel strips 47
 - settings 47, 49
- Inputs
 - analog 10
 - mic/instrument 22
 - optical 10, 25
 - S/PDIF (TOSLink) 25
- Inputs section (front panel display) 9
- Inputs tab (CueMix Pro) 41
- Insert/preamp gain 23, 41
- Inserts 22
- Installation
 - hardware 19
 - iOS connection 19, 20
 - QuickStart Guide 7
 - software 16, 17
 - USB connection 19

- iOS operation 17, 19, 20, 61
- iPad
 - support 17
- iPhone
 - support 17

L

- Latch 34, 56
- Latency 18, 40, 65, 66
- Latency performance 17
- Level 34, 57
- Lightening cable connection 20
- Lightpipe 25
- Line inputs
 - boosting 23
- Line outputs
 - Monitor Group 42
 - trimming 23, 42
- Linear Phase Fast/Slow filter options 35
- Live 63
- Lock icon 30
- Logic Pro 62, 63
 - clock source 62
 - sample rate 62
- Loopback 67

M

- M buttons 42
- macOS 62
 - audio software
 - clock source 62
 - sample rate 62
 - compatibility 15
 - system requirements 15
- Main outs
 - A/B/C monitoring 24
 - jacks 10
 - mixer channel strip 48
- Main Volume 39
- Mains (mixer inputs) 45
- Media Clock 76
- Media Clock stream 76
- Menu knob 9
- Meter View 9, 30, 31
- Metering 29
 - customizing 30, 31
 - inputs 9
 - optical 41, 42
 - pre-fader 47
- Mic inputs
 - preamp gain/pad/48V 9
- Mic Inputs (Inputs tab) 41
- Mic insert 10
 - send 10
- Mic/instrument inputs 22
 - inserts 22
 - overview 12
- Minimum Phase (Default) filter option 35
- Mix
 - Sends 47, 49, 52
 - Settings 45
- Mixer

- effects 53
- input channel strip settings 47, 49
- stand-alone operation 53

- Mixing tab (CueMix Pro) 45
 - bus channel strips 48
 - Input channel strips 47

Monitor

- A/B output assignments 32
- A/B select 34
- A/B/C select 56
- bus channel strip 48
- bus follow menu 48
- Group 32, 39, 42
- group volume control 9, 42
- surround 9, 10, 32, 42
- volume 39
- volume control 9, 29, 31, 34, 56

- MONO button 9, 32

MOTU

- Digital Performer 63
- Performer Lite 63
- Pro Audio v2 ASIO driver 17
- Pro Audio v2 Installer 7, 16, 37

- Multiple Destinations 64
- Mute 47, 48
- MUTE button 9, 32

N

- Network
 - daisy-chain 21
 - front panel menu item 31
 - ports (rear panel) 10
 - status icons (front panel display) 9, 30
 - switch 22
- Networking 71-78
 - connections 74
 - input stream setup 75
 - output stream setup 75
 - overview 12
 - routing audio to/from 77
 - setup 74
 - syncing AVB devices 76
- Notch filter (EQ) 50
- Nuendo 62, 63
 - clock source 62
 - sample rate 62

O

- On Faders 45, 46
- Optical
 - connectors 10, 25
 - expander presets 31, 69
 - input format 41
 - output format 42
 - overview 12
 - S/PDIF 25
- Optimization 66
- Output Safety Offset 18, 40
- Outputs
 - analog 10
 - optical 10, 25
 - S/PDIF (TOSLink) 25

Outputs tab (CueMix Pro) 42

P

Pad 22
Pan 47
Panel Lockout 35
Parametric EQ 47, 48, 49, 50, 53
Patch thru
 latency 66
Patchbay tab (CueMix Pro) 43, 44
Peak/hold indicators 47, 48
Performance 66
Performer Lite 13, 18, 62, 63
Phantom power 22
Phase Invert 41
Phase-lock 26
Phone outputs 9, 10
Phones (see headphones)
PHONES section (front panel display) 9
Post-fader aux bus sends 45
Power button 9, 36
Power supply 10
PRE (pre/post aux send faders) 45
Preamp/insert gain 23, 41
Predelay (reverb) 55
Pre-fader 47
Presets 31, 35, 39, 59, 78
Presonus
 Studio One Pro 63
Pro Tools 62, 63
Processing 53
Processing (DSP) 12
Product registration 15
Proxy Device 38

Q

Q 50, 53
QuickStart Guide 7

R

Rack installation 7
Ratio 51
 Compressor 54
Re-amping 24
Reaper 62, 63
Rear panel
 Network ports 10
 Thunderbolt ports 10
Reason 62
 Propellerhead Reason 63
Registration 15
Release
 Compressor 54
 Gate 54
Reset 31, 57
Return 22
return 10
Reverb 55
 accessing 48, 55
 bus 48
 room size 55

 routing to/from 55
 settings 55
Routing tab (CueMix Pro) 44

S

S/PDIF
 optical 25
 optical input format 41
 optical output format 42
Sample rate 40
Save Preset to File 59
Select button 9
Send 10
Send/return 22
Serial number 31, 40
Shelf filter (EQ) 50
Show/hide virtual 10pre 38
SMUX 25
Software installation 7, 16, 17, 37
Solo 45, 47, 48
 bus 48
Sources bank (Patchbay) 43
Stage monitors
 connecting 8
Stand-alone operation 29
Steinberg
 Cubase 63
 Nuendo 63
Stereo Link button 49
Stream format 75
Studio One Pro 63
Studio setup (example) 8
Surround monitoring 9, 10, 32, 42
Switch (AVB) 22
Synchronization 25, 26
 AVB devices 76
Synths
 connecting 8
System requirements
 minimum 15
 recommended computer 15

T

Talk button 34, 56
Talkback 34, 39, 45, 56-57
 dim 34, 57
 latch 34, 56
 level 34, 57
 settings 34, 56
 setup 34, 56
Technical specifications 82
Technical support 80
Threshold 51
 Compressor 54
 Gate 54
Thru (word clock) 10, 27, 40
Thunderbolt
 cable 15, 19
 channel naming 64
 connection 15, 19
 connection status 9
 connectivity 11

 daisy-chaining 21
 devices (connecting) 21
 dock (connecting) 21
 ports 10

Time Sensitive Networking (TSN) 71
Timeout (display) 31
TOSLink 10, 12, 25, 41, 42
Trim 22
Troubleshooting 80
TRS analog inputs/outputs 23
TSN 71

U

Undo/Redo (Patchbay) 43
Unlock Front Panel 35
Update button 38
Updating firmware 59
USB
 cable (included) 15, 19
 camera adapter kit 20
 channel naming 64
 connection 19
 connection status 9
 hub (connecting) 21
 installing drivers 16, 17
 loopback channels 67
 USB4 operation 19
User presets 35

V

Volume control 9, 29, 31, 39
Volume knob 9

W

Wave driver 63
WDM (Wave) Driver 17
WDM Input/Output Streams 40
Width (reverb) 55
Windows
 system requirements 15
 Wave driver streams 40
 WDM (Wave) driver 17
 WDM Input/Output Streams 40
 Windows
 latency 40
Word Clock 40
Word clock 10, 13
 specifications 83
 synchronization 26
 Thru 27, 40