

R12

MultiTrak

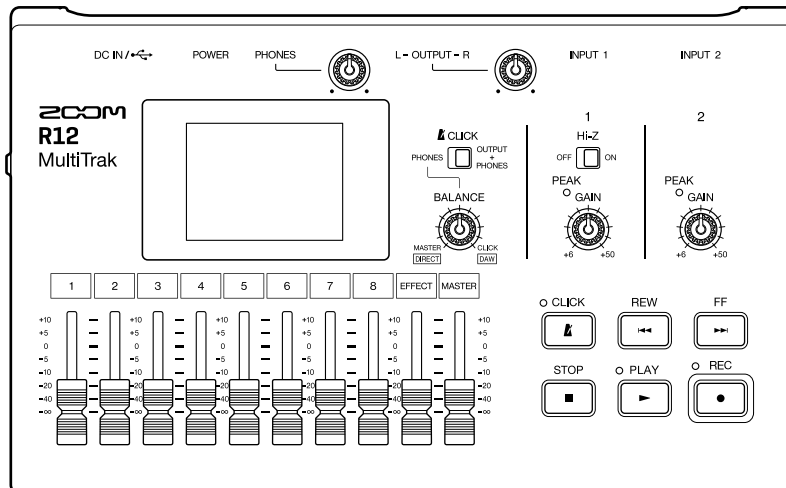

Operation Manual

You must read the Usage and Safety Precautions before use.

©2022 ZOOM CORPORATION

Copying or reprinting this manual in part or in whole without permission is prohibited.

Product names, registered trademarks and company names in this document are the property of their respective companies. All trademarks and registered trademarks in this document are for identification purposes only and are not intended to infringe on the copyrights of their respective owners.

Proper display is not possible on grayscale devices.

Notes about this Operation Manual

You might need this manual in the future. Always keep it in a place where you can access it easily. The contents of this document and the specifications of the product could be changed without notice.

- Windows® is a trademark or registered trademark of Microsoft® Corporation.
- iPad, iPadOS and Mac are trademarks of Apple Inc.
- App Store is a service mark of Apple Inc.
- iOS is a trademark or registered trademark of Cisco Systems, Inc. (USA).
- The SD, SDHC and SDXC logos are trademarks.
- Recording from copyrighted sources, including CDs, records, tapes, live performances, video works and broadcasts, without permission of the copyright holder for any purpose other than personal use is prohibited by law. Zoom Corporation will not assume any responsibility related to infringements of copyrights.

Contents

Notes about this Operation Manual.....	2
R12 overview.....	6
Terms used in this manual.....	6
Functions of parts.....	7
Connection example.....	12
Touchscreen display.....	13
Home Screen overview.....	13
Control Bar overview.....	18
Touchscreen operation overview.....	21
Making preparations.....	24
Inserting microSD cards.....	24
Connecting output devices.....	25
Supplying power.....	26
Turning the power on/off.....	28
Setting the date and time (first time starting up).....	30
Opening projects.....	32
Creating new projects.....	33
Opening projects.....	38
Changing project settings.....	40
Opening the screen where various project settings can be made.....	40
Changing project tempos.....	41
Changing project time signatures.....	42
Setting the click (metronome).....	43
Setting tracks for output as MASTER and CLICK signals.....	47
Changing the snap setting.....	49
Using the tuner.....	50
Selecting the tuner type.....	51
Setting the standard pitch of the tuner.....	52
Using flat tunings.....	52
Recording.....	53
Recording process.....	53
Making input settings.....	54
Making track settings.....	63
Using effects.....	69
Editing patch memories.....	73
Recording.....	79
Using internal rhythm loops.....	81
Using the synthesizer.....	84
Selecting the synth sound.....	84
Recording.....	86

Playing projects.....	87
Editing projects.....	89
Editing regions.....	89
Editing waveforms (audio/rhythm regions).....	105
Editing notes (synth regions).....	110
Editing tracks.....	115
Using markers.....	121
Mixing projects.....	127
Checking track levels.....	127
Muting tracks.....	128
Listening to selected tracks only (soloing).....	129
Adjusting the volume.....	130
Adjusting the panning, EQ and effects of tracks.....	132
Mixing down.....	133
Managing projects.....	134
Folder and file structure on microSD cards.....	134
Folder and file structure on USB flash drives.....	136
Opening the Project Option Menu.....	138
Changing project names.....	140
Duplicating projects.....	141
Checking project information.....	142
Deleting projects.....	143
Rendering projects as WAV files.....	144
Saving projects to USB flash drives.....	146
Importing projects from USB flash drives.....	147
Using as an audio interface.....	149
Installing drivers.....	149
Connecting computers, smartphones and tablets.....	150
Making audio interface settings.....	153
Using as a control surface.....	156
Enabling control surface use.....	156
Making DAW settings.....	156
R12 functions.....	157
Playing back projects in order (sequential play).....	158
Creating playlists.....	158
Editing playlists.....	161
Deleting playlists.....	163
Changing playlist icon colors.....	164
Playing playlists.....	165
Using Guitar Lab.....	169
Connecting to a computer.....	169
Using MIDI keyboards.....	172
Connecting MIDI keyboards.....	172
Setting the Auto Power Off function.....	173

Setting the date and time.....	174
Setting the type of batteries used.....	176
Adjusting the brightness of the touchscreen.....	177
Setting the touchscreen backlight.....	178
Managing microSD cards.....	179
Checking microSD card information.....	179
Testing microSD card performance.....	180
Formatting microSD cards.....	182
Using as a card reader.....	184
Restoring default setting values.....	187
Managing the firmware.....	189
Checking the firmware versions.....	189
Updating.....	189
Appendix.....	190
Troubleshooting.....	190
Block diagram.....	191
MIDI implementation chart.....	192
Specifications.....	193

R12 overview

Terms used in this manual

Multitrack recorder (MTR)

A recorder that can record and play multiple tracks is called a multitrack recorder (MTR). The R12 can simultaneously record up to 2 tracks and simultaneously play up to 8 tracks.

Project

The R12 manages recording and playback data for a single song in a unit called a project. The audio files assigned to tracks and settings, including for panning and faders, are saved in project files. Up to 1000 projects can be created on a single card.

Region

The data from a single recording is managed for each track in units called regions. Regions for audio recordings and rhythms are shown as waveforms while synthesizer regions are shown as performance data (MIDI notes). Moreover, WAV and MIDI files on microSD cards and USB flash drives can be added as regions.

Snapping

This function aligns regions to a grid when they are moved or edited. This enables editing to be conducted efficiently.

MIDI file

This type of file contains MIDI performance data. The R12 can load MIDI files and add them as synth regions.

Effect

A wide variety of effects can be applied to sounds, including distortion, chorus and reverb. By adjusting effect parameters, you can create your own original sounds.

Patch memory

Patch memories store the effects used, their on/off states and parameter settings, allowing easy recall. Effects are saved and recalled in units of patch memories. Up to 3 effects can be added to a patch memory, and up to 50 patch memories can be stored.

Functions of parts

Top

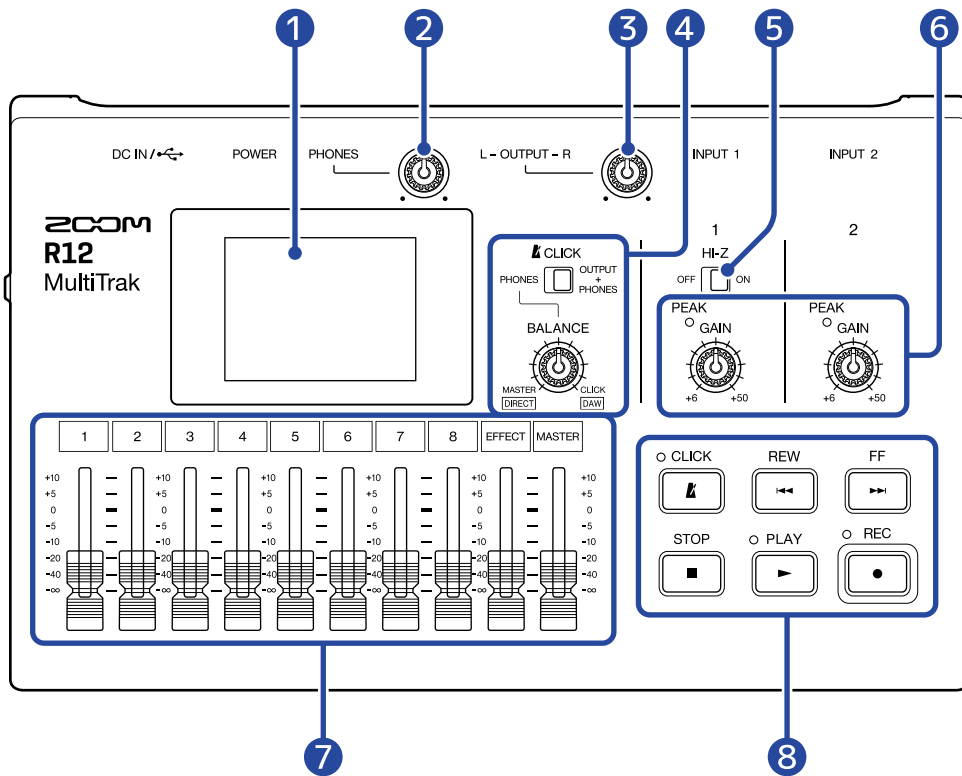

1 Touchscreen

This shows various types of information and is operated by touch.

2 PHONES volume knob

Use to adjust the headphone volume.

3 OUTPUT volume knob

This adjusts the OUTPUT volume.

4 BALANCE knob / CLICK switch

When the CLICK switch is set to PHONES, use the BALANCE knob to adjust the balance between the MASTER and CLICK signals output from the PHONES jack.

5 Hi-Z switch

Turn Hi-Z on/off for INPUT 1. Turn this on as necessary for the connected guitar or bass.

6 Input PEAK indicators / GAIN knobs

Use the input GAIN knobs to adjust input signals. Adjust these so that the PEAK indicators do not light.

7 Channel/EFFECT/MASTER faders

Channel faders: These adjust individual track signal levels in a range from $-\infty$ to +10 dB.

EFFECT fader: This adjusts the return level of the send effect in a range from $-\infty$ to +10 dB.

MASTER fader: This adjusts the signal levels of the MASTER track, which is a stereo mix of the individual tracks, in a range from $-\infty$ to +10 dB.

8 Other buttons



This turns the click (metronome) on/off. The indicator lights when it is on.



Press to skip back one bar. Press and hold to search backward.



Press to skip forward one bar. Press and hold to search forward.



Press this to stop recording and playback. Press when stopped to move the recording/playback position to the beginning of the project.



Press to start/pause playback of recorded files. The indicator lights during playback.



Press to start recording. The indicator lights during recording.

Bottom

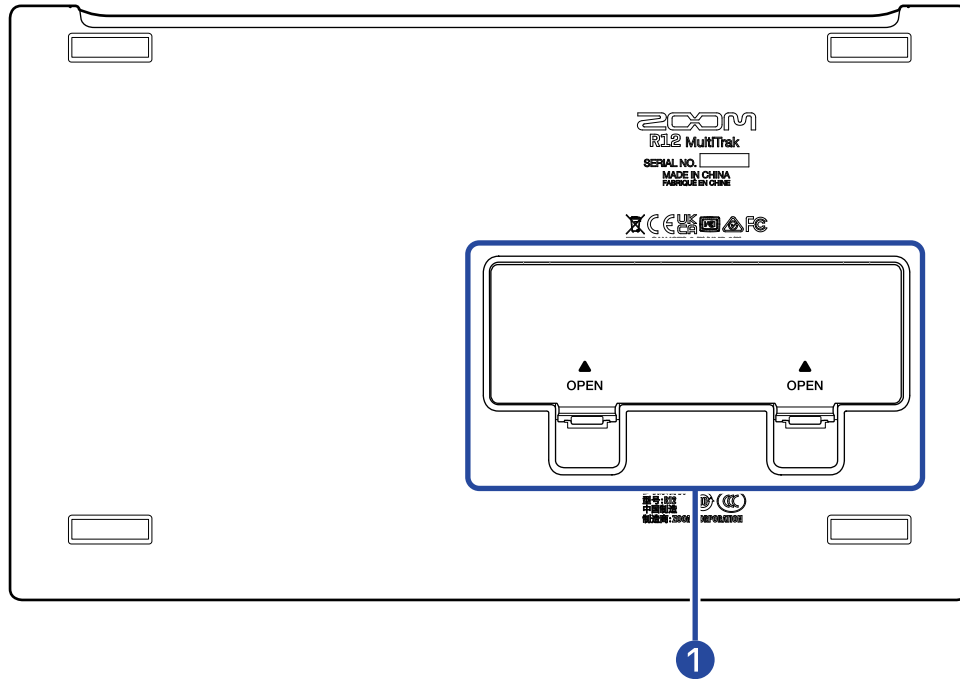

- 1 Battery compartment cover**
Open this when installing or removing AA batteries.

Side

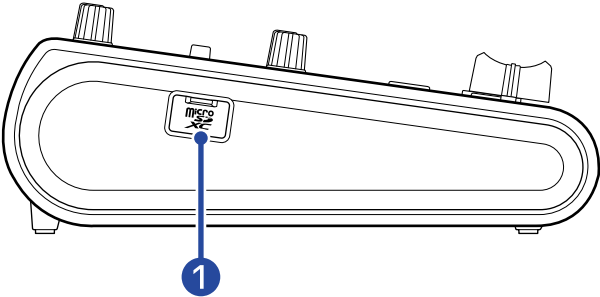

1 microSD card slot

This supports cards that meet microSDHC/microSDXC specifications.

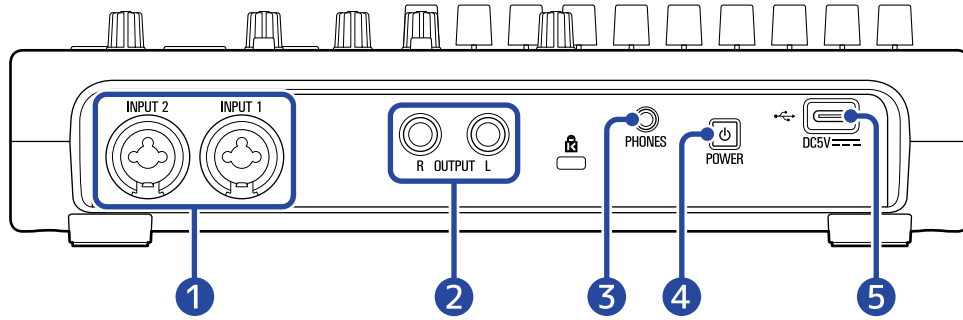

1 INPUT 1–2 jacks

Connect mics, keyboards and guitars to these. These support XLR and 1/4-inch phone (unbalanced) plugs.

2 OUTPUT jacks

Connect these to a power amplifier, a PA system or powered monitor speakers, for example.

3 PHONES output jack

Connect headphones here.

4 Power button

Press and hold this to turn on/off the R12 power.

When switched off, the current mixer settings are automatically saved in the R12 and in the settings file in the project folder on the microSD card.

5 USB (Type-C) port

Using this, projects can be copied to and imported from USB flash drives. USB MIDI keyboards can also be connected and used to play synth sounds.

Using a hub that supports the USB Power Delivery function, power can be supplied to the R12 while using a USB flash drive or USB MIDI keyboard.

Connecting to a computer also makes the following possible.

- The R12 can be used as an audio interface.
- Guitar Lab can be used to replace R12 effects.
- The R12 can be used as a card reader.
- The R12 can be used as a DAW control surface.

Connection example

This is an example of connections to record vocals and guitars.

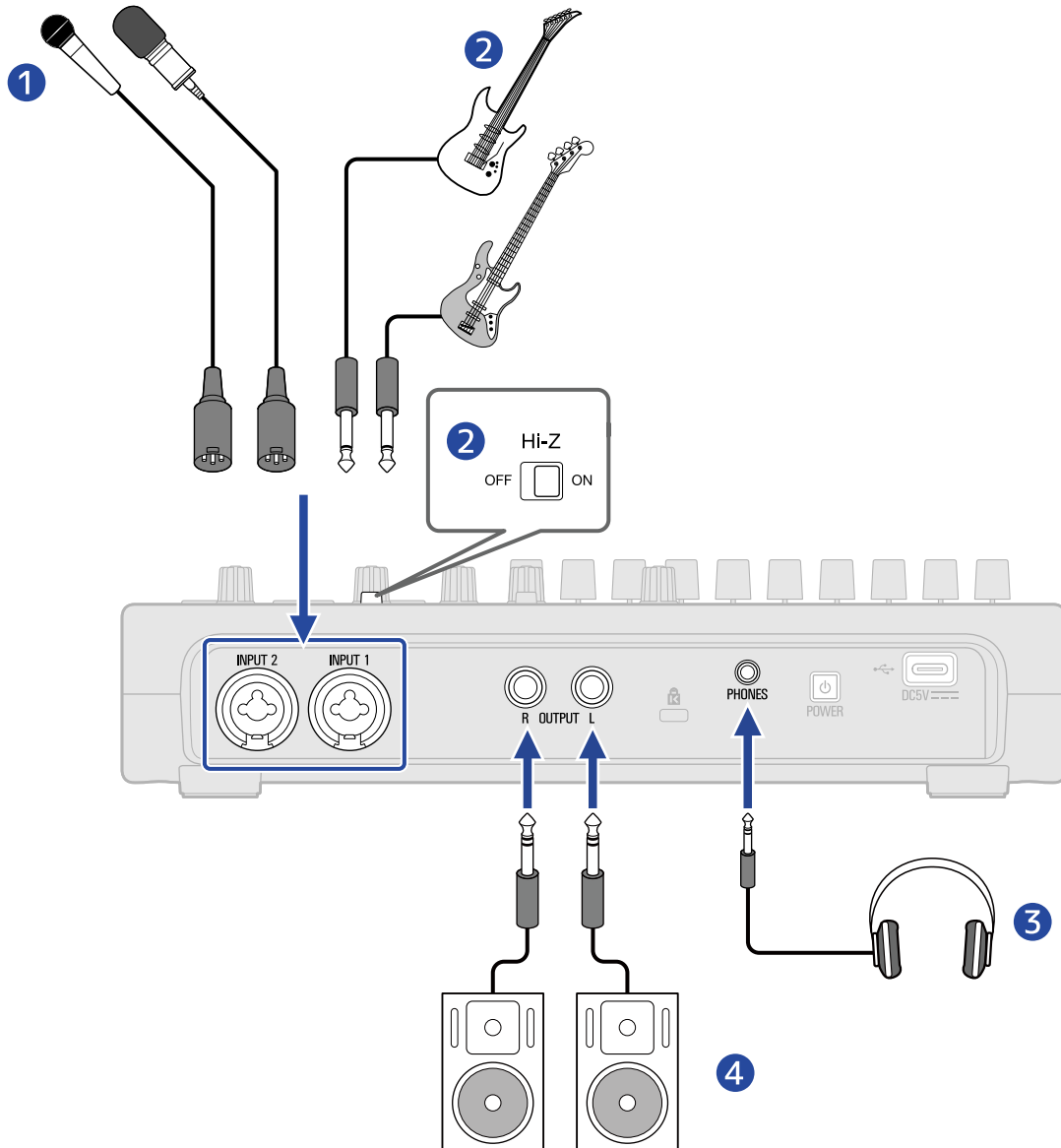

1 Mics for lead and backing vocals, drums and other sound sources

Dynamic and condenser mics can be connected. When a condenser mic is connected, turn on phantom power. (→ [Enabling tracks for recording](#))

2 Guitars, basses and other instruments

When directly connecting a guitar or bass with passive pickups, use **INPUT 1** and set **Hi-Z** **ON**.

When connecting a guitar or bass with active pickups or through an effect, for example, to the R12, use either **INPUT 1** or **2**. In this case, set **Hi-Z** **OFF** when connecting to **INPUT 1**.

3 Headphones

4 Powered monitors

Touchscreen display

The R12 touchscreen shows information necessary for operation. Tap and slide on the screen to conduct various operations, including selecting, adjusting and editing.

This section explains various screens shown on the R12.

Home Screen overview

This appears on the touchscreen when the R12 power is turned on. The Home Screen has two views: Track View and Level Meter View. Switch between them as needed during operation.

Track View Screen

This is the normal recording/editing screen.

Since recorded waveforms and their positions can be examined easily, this is useful for thinking about song structure and editing.





1 Control Bar

This shows the recording/playback position and various buttons. See the [Control Bar overview](#) for details.

2 Track Headers

These show track numbers and types. Tap this to select a track, highlighting it. Tracks armed for recording are shown in red.

- **1 - 8** : Audio tracks
These show regions with recorded audio.
-  : Rhythm track
This shows rhythm loop regions.
-  : Synth track
This shows synth (MIDI data) regions.

Slide the Track Headers right to open the mixer. When the mixer is open, slide the Track Headers left to close it.

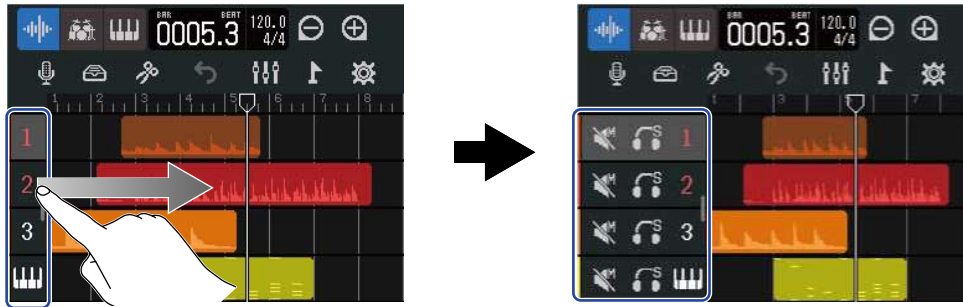

Use the mixer to check the mute (→ [Muting tracks](#)) and solo (→ [Listening to selected tracks only \(soloing\)](#)) settings of each track.

3 Regions

Audio and rhythm regions are shown as waveforms while synthesizer regions are shown as notes. See [Editing regions](#) for details about region operations, including moving, adding, deleting and dividing them.

NOTE:

The maximum numbers of regions in a single project are as follows.

- Total number of audio and rhythm regions: 50
- Synth regions: 80

4 Tracks

These show regions.

The display can be changed by doing the following.

- Tap  to zoom out on the timeline display. (This enables showing many bars at the same time.)



- Tap  to zoom in on the timeline display. (This enables displaying more detail.)



- Slide up, down, left or right to show tracks that were hidden and to change the part of the timeline that is visible.



Level Meter View Screen

This screen shows the level meters and faders for all tracks.

This screen makes observing the volume of all tracks easy, so it is useful for recording multiple channels simultaneously and balancing the mix.

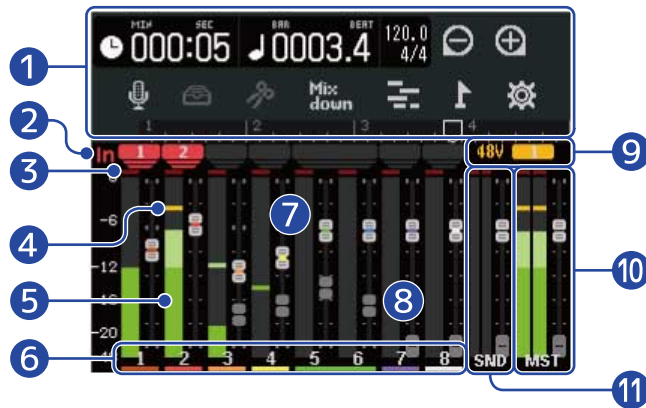

1 Control Bar

This shows the recording/playback position and various buttons. See the [Control Bar overview](#) for details.

2 Input indicators

The show the input jack (1/2) track assignments.

3 Clipping indicators

These light red if input/playback signal levels are clipping after fader adjustment.

Pressing , starting recording or changing screens will clear these indicators.

4 Peak indicators

These retain the peak levels of input/playback signals for a set amount of time after fader adjustment.

5 Track level meters

These show the input/playback signal levels after fader adjustment.

6 Tracks

These show the track numbers.

Tap a track to open the Track Settings Screen

7 Track faders

These show the current fader position settings.

8 Track ghost faders

When the positions of physical faders and fader settings are different because the screen has been switched, for example, these show the physical fader positions.

To change the fader setting value, move the fader on the unit to the current fader position. This will cause it to reflect the unit fader position.

9 Phantom power indicator

When phantom power is on, this shows the input that is receiving it.

10 MASTER fader and level meters

This shows the MASTER fader position and MASTER track levels.

11 EFFECT fader and level meters

This shows the EFFECT fader position and EFFECT track levels.

Control Bar overview

The control bar is shown at the top of the Track View and Level Meter View screens. Along with showing the current bar position, tempo and time signature, other features include buttons for various settings.

Track View Screen





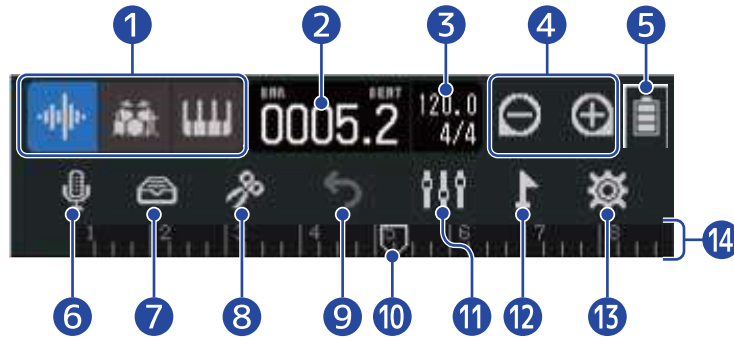

Level Meter View Screen



1 (Track View Screen only): Track Type Buttons

The selected track type can be switched.

-  -  : Audio tracks
-  : Rhythm track
-  : Synth track

(Level Meter View Screen only): Recording/playback time

This shows the time (in minutes and seconds) of the recording/playback position.

2 Recording/playback bars and beats



This shows the bar and beat of the recording/playback position.

3 Tempo and time signature

This shows the current tempo and time signature settings.
This can be tapped to open the Project Settings Screen.

4 Zoom in/out buttons

These change the magnification of the timeline display.

-  : Zoom in on the timeline display.
-  : Zoom out on the timeline display.

5 Remaining battery charge (only when battery-powered)



When the remaining battery charge becomes low, replace the batteries (→ [Installing batteries](#)), or connect the AC adapter (→ [Connecting the AC adapter](#)) or a mobile battery (→ [Using other power supplies](#)).





6 Input selection button

This opens the Input Routing Screen where INPUT 1–2 jack input, phantom power on/off, and compressor/limiter/gate settings can be made.

7 Library button



- When the track type is **1** – **8** , this opens the Patch Memory Selection Screen.
- When the track type is  , this opens the Rhythm Loop Selection Screen.
- When the track type is  , this opens the Synth Type Selection Screen.

8 Edit button

- When the track type is **1** – **8** or  , this opens the Wave Editor Screen.
- When the track type is  , this opens the Piano Roll Screen.

9 UNDO/REDO button (Track View Screen only)

This undoes the last operation.

-  : This undoes the last operation (UNDO function).
(When  is shown, the UNDO function cannot be used.)
-  : This redoes the undone operation. (REDO function)

NOTE:

UNDO/REDO can be used with the following functions.

Recording, changing region loop length, trimming/moving/deleting/pasting and splitting regions, swapping/deleting tracks, audio/MIDI input

Mixdown button (Level Meter View Screen only)

Use this to mix down recordings.



10 Recording/playback position

This shows the recording/playback position During recording, it appears red.

During playback, drag this horizontally to change the playback position.

11  **Screen Switching button**

This switches between the Track View Screen and Level Meter View Screen.

-  : This opens the Level Meter View Screen.
-  : This opens the Track View Screen.

12  **Marker button**



This opens the Marker Menu.

13  **Project Settings button**

This opens the Project Settings Screen.

14 **Ruler**

This shows bars, beats, the recording/playback position and markers.

Tap  /  to increase/decrease the magnification of the timeline.

Touchscreen operation overview

Operations on various screens

Tap and slide on the touchscreen to operate it.

Tap: Select

Tap a value you want to set. The current setting value is shown in blue.

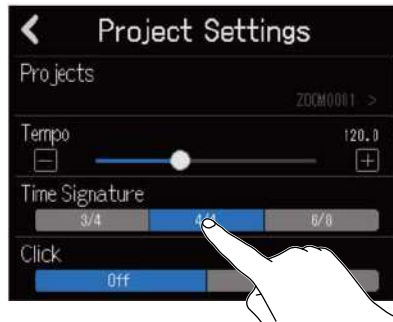

Tap: Change settings

Tap  and  to change settings.



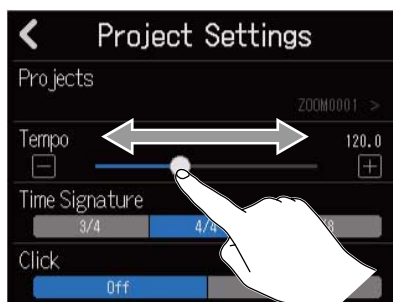

Slide: Adjust

While touching a slider, move it horizontally to adjust the setting value.



HINT:

- Tap  or  at the ends of the slider to change the value by 1.
- Double-tap a slider to reset it to its initial value.

Slide: Scroll through items

While touching the display, slide vertically to scroll.

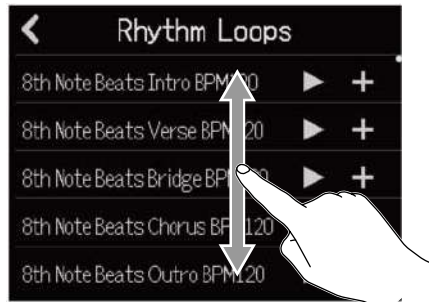

Returning to the previous screen/Home Screen (Track View Screen / Level Meter View Screen)

Tap  at the top left of the screen.

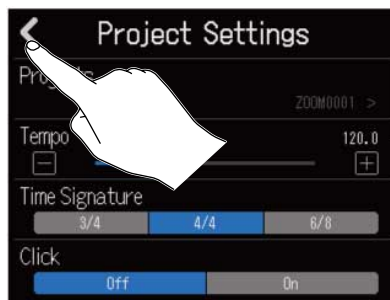

To return to the Home Screen, tap  repeatedly until it opens.

Character Input Screen overview

The Character Input Screen appears on the touchscreen to enable file names to be input and edited, for example.

Tap the keyboard to input characters.

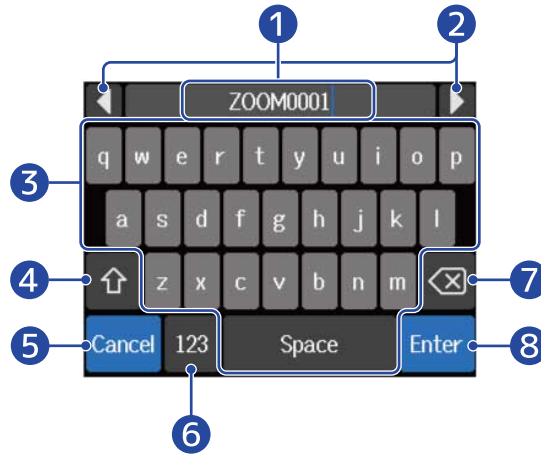

- 1 Character input area
A cursor shows the input position.
- 2 Move cursor
- 3 Keyboard
Use to input characters.
- 4 Switch between uppercase and lowercase
- 5 Cancel input
This reopens the previous screen.
- 6 Change character type
- 7 Delete character
- 8 Confirm input

NOTE:

The characters and symbols that can be used are as follows.

! # \$ ' () + , - ; = @ [] ^ _ ` { } ~ (space) A-Z, a-z, 0-9

Making preparations

Inserting microSD cards

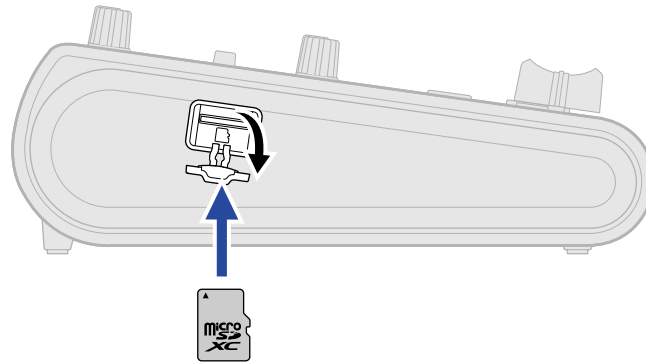

- 1.** Turn the power off and then open the microSD card slot cover.
- 2.** Insert the microSD card into the microSD card slot.
To remove a microSD card, push it further into the slot and then pull it out.

NOTE:

- Cards that conform to SDHC and SDXC specifications are supported.
- Always make certain that the power is off when inserting or removing a microSD card. Inserting or removing a card while the power is on could result in data loss.
- When inserting a microSD card, be sure to insert the correct end with the top side up.
- Recording and playback are not possible when a microSD card is not loaded in the R12.
- After purchasing a new microSD card, always format it using the R12 to maximize performance. (→ [Formatting microSD cards](#))

Connecting output devices

Powered monitors and headphones can be connected to check the sound.

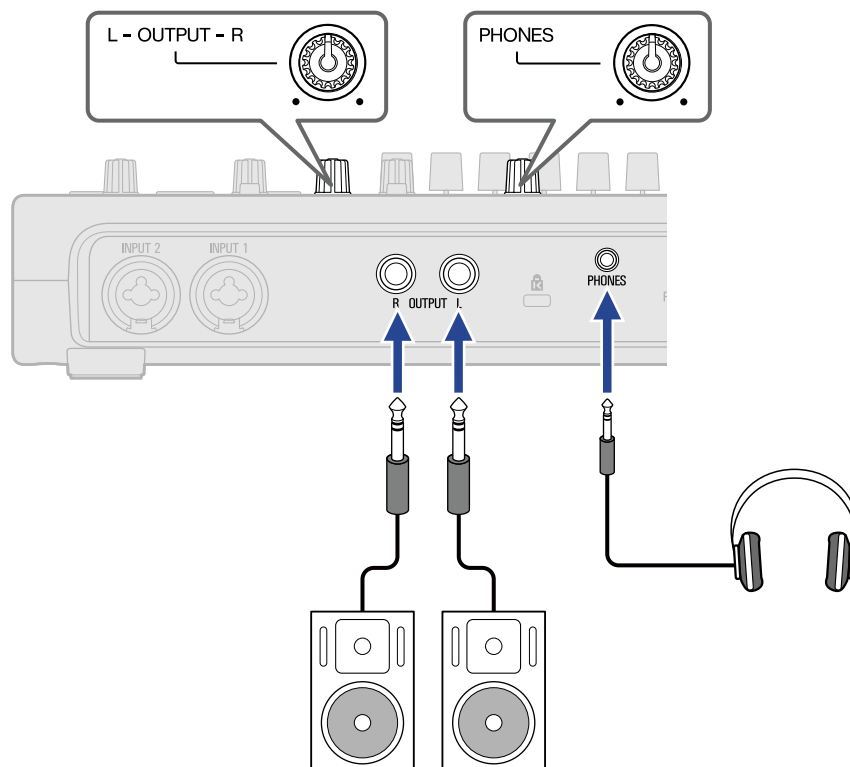

Use OUTPUT  to adjust the OUTPUT volume.

Use PHONES  to adjust the headphone volume.

NOTE:

Turn powered monitors off before connecting them.

HINT:

The OUTPUT jacks support balanced output.

Supplying power

The R12 can be operated using power from a power supply connected to the USB port (AC adapter, USB bus power or mobile battery) or AA batteries.

A power supply connected to the USB port will be used instead of AA batteries when available.

Installing batteries

To operate the R12 using batteries, press and lift  OPEN to open the battery compartment cover on the bottom. Then, insert 4 AA batteries.

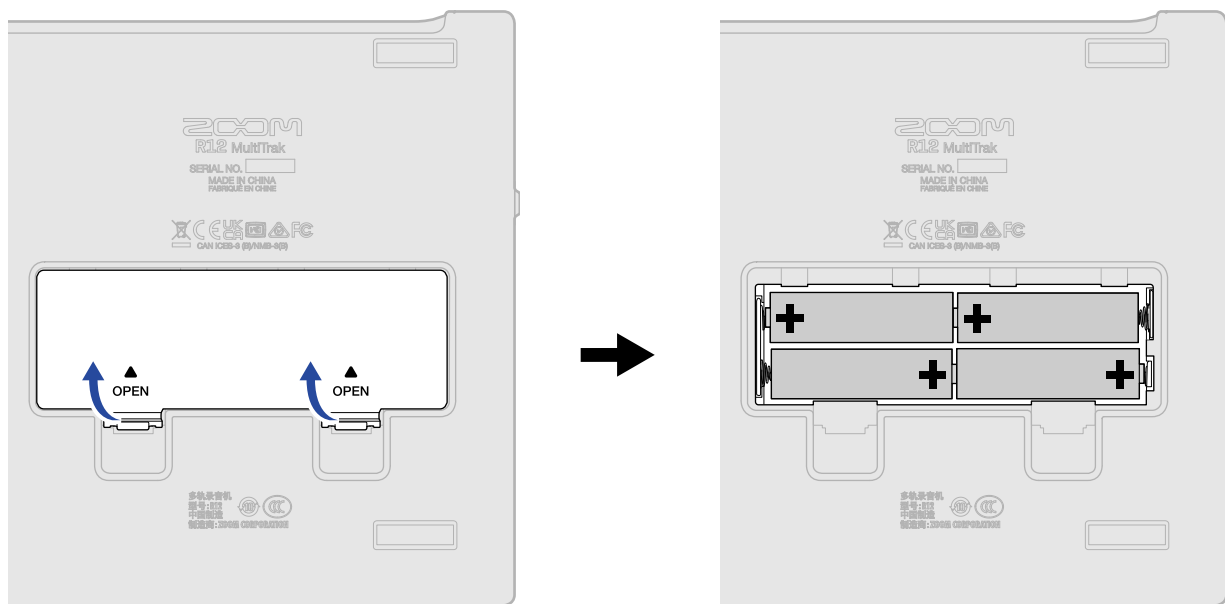

NOTE:

- Use only one type of battery (alkaline, NiMH or lithium) at a time.
- The remaining battery charge is shown on the display. (→ [Control Bar overview](#))
- Set the type of battery used correctly so that the amount of remaining battery charge can be shown accurately. (→ [Setting the type of batteries used](#))
- If the indicator shows no remaining battery charge, turn the power off immediately and install new batteries. The remaining battery charge is always shown (on most screens) when operating on battery power.

Connecting the AC adapter

Connect the cable of the dedicated AC adapter (AD-17) to the USB port (Type-C). Then, plug the AC adapter into an outlet.

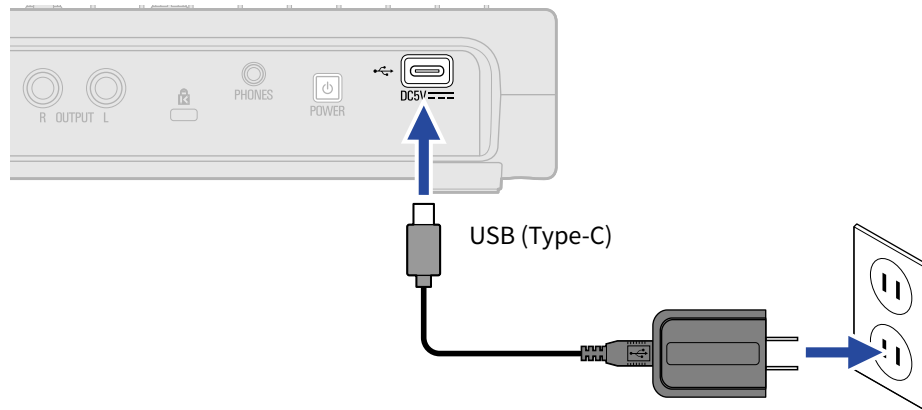

Using other power supplies

The R12 can be operated using bus power from a computer connected to the USB port (Type-C). A 5V mobile battery (commercially-available) can also be used for power.

Turning the power on/off

Turning the power on

1. Confirm that the output devices connected to the R12 are turned off.

2. Set all  and faders to their minimum values.

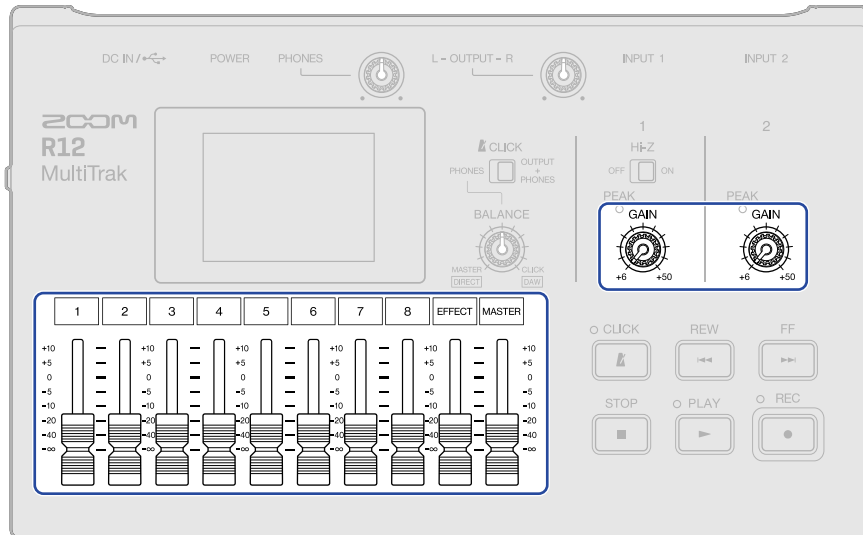

3. Press  until the  and  indicators light.

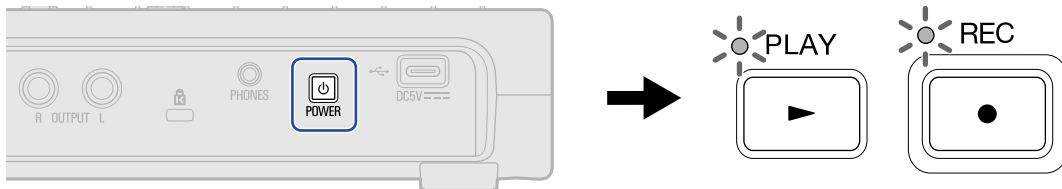

This turns the R12 power on, opening the Projects Screen (→ [Opening projects](#)) or Home Screen (→ [Home Screen overview](#)) on the touchscreen.

The first time the power is turned on after purchase, as well as after the R12 has been reset to factory defaults, the Date/Time Setting Screen will open. Set the date and time when it does. (→ [Setting the date and time \(first time starting up\)](#))

4. Turn on the output devices connected to the R12.

NOTE:



- The power will automatically turn off if it is unused for 10 hours. To keep the power on at all times, disable the automatic power saving function. (→ [Setting the Auto Power Off function](#))
- If “No SD Card!” appears on the display, confirm that a microSD card is inserted properly. (→ [Inserting microSD cards](#))
- If “Invalid SD card!” appears on the display, the card is not formatted correctly. Format the microSD card (→ [Formatting microSD cards](#)) or load a different microSD card (→ [Inserting microSD cards](#)).

Turning the power off

- 1.** Minimize the volume of output devices connected to the R12.
- 2.** Turn off the output devices connected to the R12.
- 3.** Press  until “Goodbye! See You!” is shown.
The touchscreen display will turn off.

Setting the date and time (first time starting up)

The first time the power is turned on after purchase, set the date and time when the Date/Time Setting Screen opens. This is used to add the date and time to recorded files.

1. Tap  /  to set the date and time.

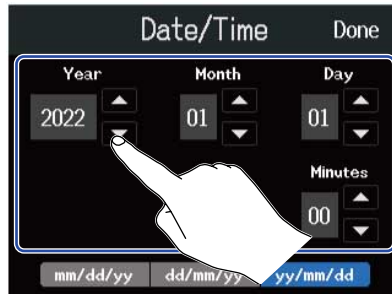

2. Tap the displayed date format to use.

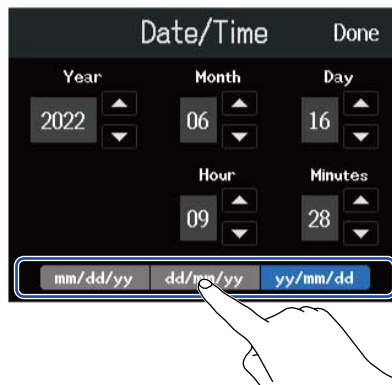

- mm/dd/yy: month/day/year
- dd/mm/yy: day/month/year
- yy/mm/dd: year/month/day

3. Tap "Done".



This confirms the set date and time and opens the Projects Screen. Create a new project. (→ [Creating new projects using templates](#) and [Creating empty projects using specific settings](#))

NOTE:

If power is not supplied for a while, the stored date and time settings will be reset. If the Date/Time Setting Screen appears during startup, set them again.

HINT:

The date and time setting can also be changed later from the Menu screen. (→ [Setting the date and time](#))

Opening projects

The R12 saves and manages recording and playback data in units called projects.

A list of projects is shown on the Projects Screen. Tap a project to select it for recording, playback and editing. New projects can also be created on the Projects Screen.

Follow these steps to open the Projects Screen.

1. Tap  on the Home Screen (Track View Screen/Level Meter View Screen).

Track View Screen



Level Meter View Screen



2. Tap "Projects".

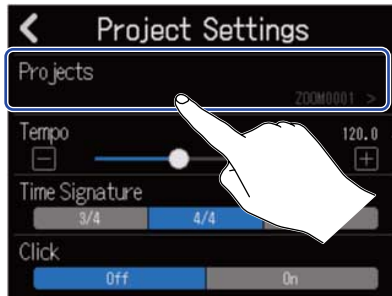

This opens the Projects Screen.



Creating new projects

Templates that already have rhythm loops included can be selected for various genres to create projects that make starting a music project easy. Projects can also be made by first setting the tempo and time signature, for example.

NOTE:

- Up to 1000 projects can be created on a single card.
- Projects are saved automatically at the following times.
 - When the Projects Screen is opened from another screen
 - When recording completes
 - When the power is turned off
 - When a new project is created
 - When the Project Settings Screen is closed

Creating new projects using templates

Projects can be created from templates for various genres that have rhythm loops assigned to them in advance.

Templates have been prepared for popular genres including rock, funk and hip-hop.

1. Tap "Templates" on the Projects Screen.



2. Tap the desired genre.



The selected genre will be framed in blue.

3. Tap "Create".

This will create a new project and open the Track View Screen, showing the rhythm loop for the selected genre.

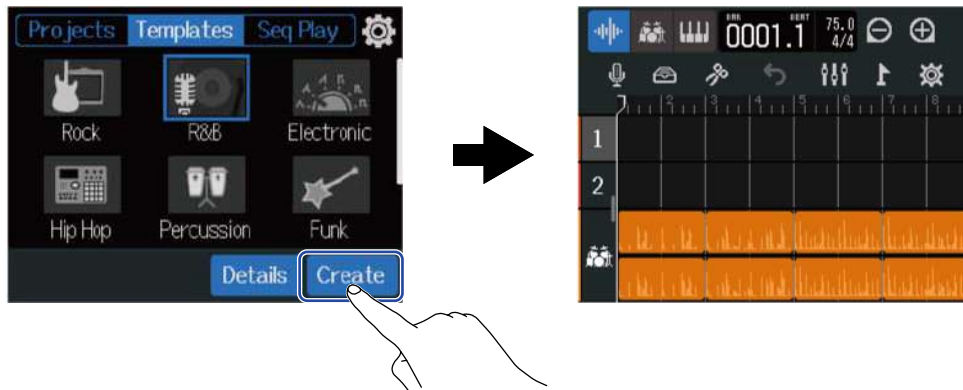

HINT:

- Projects will be named "ZOOM0001" - "ZOOM9999". Project names can be changed later. (→ [Changing project names](#))
- Tap "Details" to set the bit depth before creating a project.

Creating empty projects using specific settings

Projects can be made after setting the tempo, time signature and bit depth. The tempo and time signature can also be changed later from the settings.

1. Tap "Projects" on the Projects Screen.



2. Tap "New Project" to select it.



3. Tap "Details".

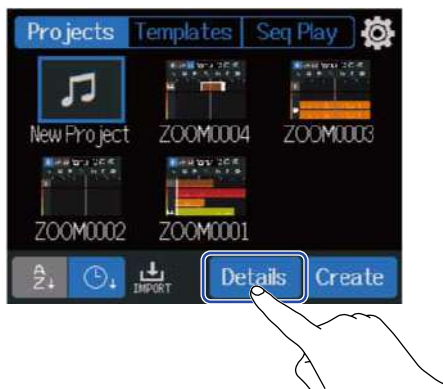

Tapping "Create" will create a project without changing settings.

4. Change the project settings by tapping and sliding.

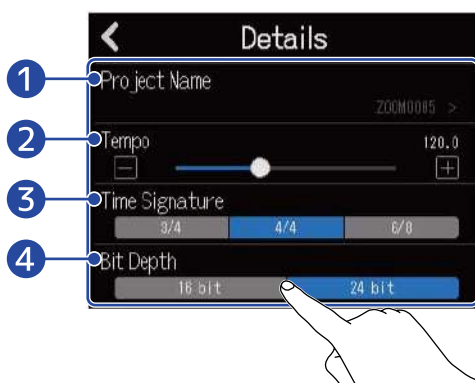

1 Project name editing

Tap this to open the Character Input Screen. See [Character Input Screen overview](#) for editing procedures.

2 Tempo

This changes the setting of the tempo used for the entire song (40.0–250.0). (→ [Changing project tempos](#))

3 Time Signature

This changes the setting of the time signature used for the entire song. (→ [Changing project time signatures](#))

4 Bit Depth

This sets the amount of data per digital signal sample. The 24-bit option captures more information, increasing audio detail and expression, but it also creates more data.

NOTE:

Bit Depth cannot be changed later.

HINT:

By default, projects are automatically named "ZOOM0001" - "ZOOM9999". Tap ⓘ to create a project with an edited name. That name will be saved and used when creating new projects, adding consecutive numbers in a "01" format automatically to the ends of their names.

Project names can be changed later. (→ [Changing project names](#))

5. Tap "Create".

This will create a new project with the changed settings, and open the Home Screen.

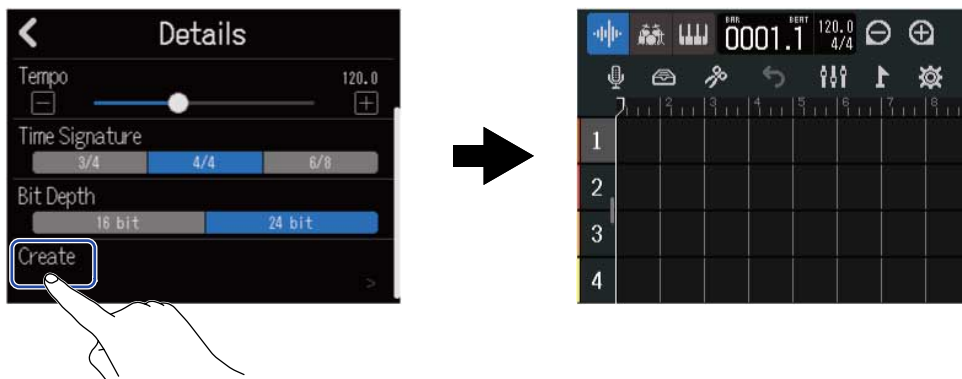

NOTE:

The settings made on the Details Screen are saved. The same settings will be used when creating new projects later.

Tapping "Create" on the Projects Screen without making settings on the Details Screen will create a new project using the Tempo, Time Signature and Bit Depth settings previously made on the screen.

Opening projects

1. Tap "Projects" on the Projects Screen.





2. Tap the desired project to select it.



The selected project will be framed in blue.

HINT:

Tap  (project name order) or  (date and time used order) to change the order shown.

3. Tap "Open".
The project selected on the Home Screen will be shown.

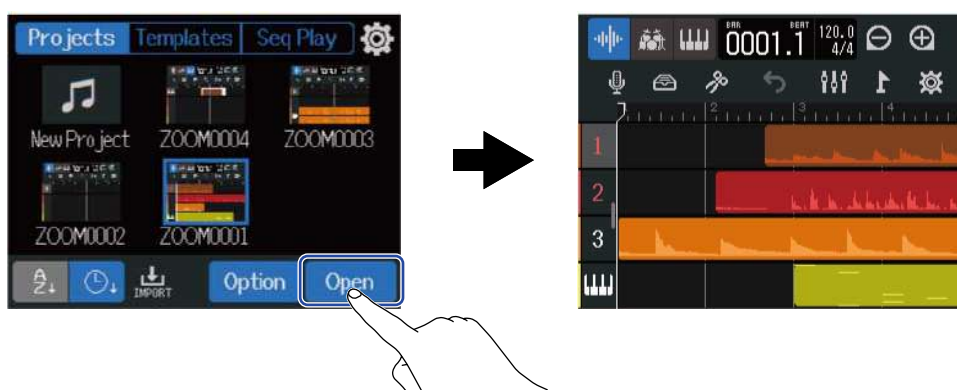

NOTE:

If the opened project file has a problem, the "Project Open Error!" message will appear. Follow these procedures to repair the project.

1. Tap "Execute".



This will repair and open the project.
Tap "Cancel" to cancel repair.

2. Tap "Close".

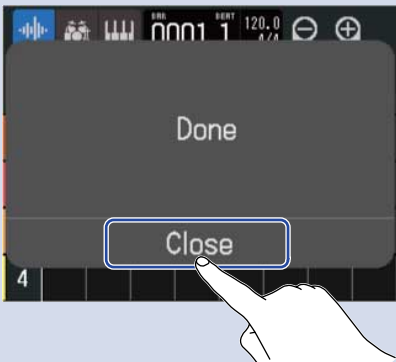

After repairing a project, a warning mark will be added to the original invalid project and a new repaired project will be created on the Projects Screen (→ [Opening projects](#)).



- ① Repaired project
- ② Original invalid project

The extension for the newly created project file will be ".r12" and the extension for the original project file will become ".r12err".

Depending on the state of the project data, it might not be repaired as intended.

Changing project settings

Various project settings can be made on the Project Settings Screen. Settings are saved separately with each project.

Project settings can be made during playback. (→ [Playing projects](#))

Opening the screen where various project settings can be made

1. Tap  on the Home Screen (Track View Screen/Level Meter View Screen).

Track View Screen



Level Meter View Screen



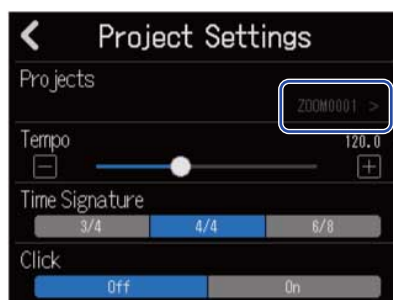

This opens the Project Settings Screen.

The name of the selected project can be checked on the Project Settings Screen.





Changing project tempos

This changes the tempo used for the entire song.

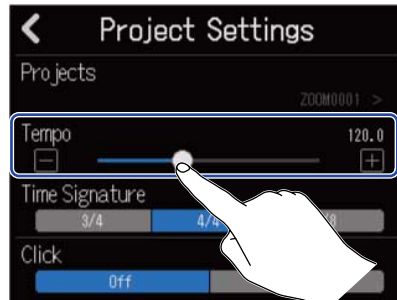
1. Slide the “Tempo” slider or tap  /  on the Project Settings Screen (→ [Opening the screen where various project settings can be made](#)).



HINT:

- This can be set from 40.0–250.0.
- The tempo set here will be shared by the effects.
- When the Project Settings Screen is open, tapping  multiple times will also set the tempo. The tempo will be calculated from the intervals between  taps (tap tempo).



If the project Time Signature is set to 6/8, the tempo sets the length of dotted quarter notes. (→ [Changing project time signatures](#))

- Tapping the tempo/time signature in the Control Bar will also open the Tempo setting of the Project Settings Screen. (→ [Control Bar overview](#))



Changing project time signatures

This changes the setting of the time signature used for the entire song.

1. Tap the desired “Time Signature” setting on the Project Settings Screen (→ [Opening the screen where various project settings can be made](#)).

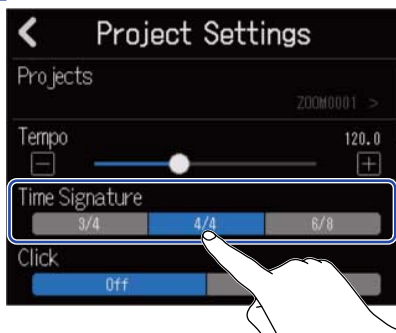

HINT:

- The options are 4/4, 3/4 and 6/8.
- Tapping the tempo/time signature in the Control Bar will also open the Time Signature setting of the Project Settings Screen. (→ [Control Bar overview](#))



Setting the click (metronome)

The R12 has a metronome with a precount function.

This metronome, which can function during recording and playback, has switchable sounds, a precount on/off setting and adjustable volume.

Using the click (metronome)

Set whether the click is used during recording and playback.

1. Tap "On" or "Off" for "Click" on the Project Settings Screen (→ [Opening the screen where various project settings can be made](#)).

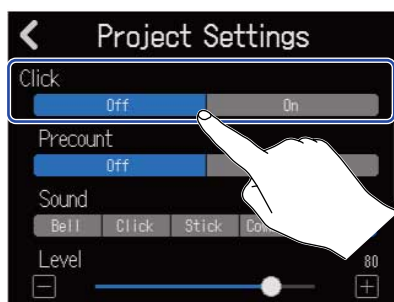

Setting	Explanation
Off	Do not use a click.
On	Use a click.

HINT:

The click can also be switched on/off by pressing  on the Home Screen.

Setting the precount

A click can be sounded before starting recording.

1. Tap "On" or "Off" for "Precount" on the Project Settings Screen (→ [Opening the screen where various project settings can be made](#)).

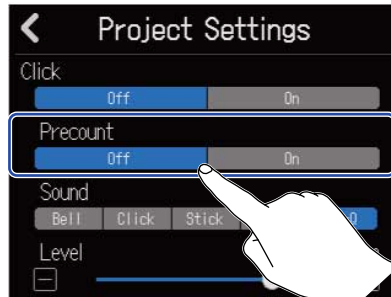

Setting	Explanation
Off	This turns off the precount.
On	This turns on the precount.

HINT:

- The number of beats in the precount depends on the time signature setting (→ [Changing project time signatures](#)).
 - 4/4: 4
 - 3/4: 3
 - 6/8: 6
 - When the precount is playing, the region before the current stop position will also be played back.
-

Changing the click sound

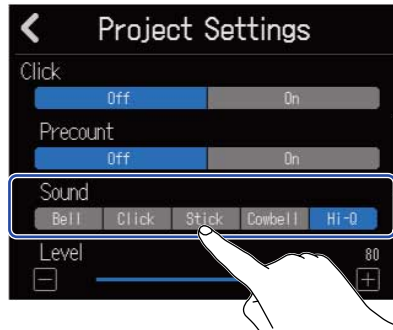

The click sound can be set to the preferred one.

1. Tap the desired “Sound” setting on the Project Settings Screen (→ [Opening the screen where various project settings can be made](#)).





Setting	Explanation
Bell	Metronome sound (with bell on accents)
Click	Metronome sound (click only)
Stick	Drumsticks tapping sound
Cowbell	Cowbell sound
Hi-Q	Synthesized click sound

Setting the click volume

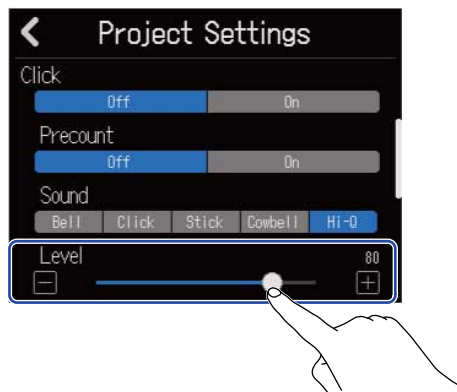
1. Slide the "Level" slider or tap  /  on the Project Settings Screen (→ [Opening the screen where various project settings can be made](#)).



HINT:

- This can be set from 0 to 100.
 - Use    to set the click output(s).
 - PHONES: The sound is output only from the PHONES jack. The balance with other output can also be adjusted. (→ [Adjusting the volume balance of the MASTER and CLICK signals output to headphones](#))
 - OUTPUT + PHONES: The sound is output from both the OUTPUT and PHONES jacks.
-

Setting tracks for output as MASTER and CLICK signals.

Set the output destination of each track.

By setting rhythm tracks, for example, to CLICK, they can be used like a click during recording, synchronized performances and other situations.

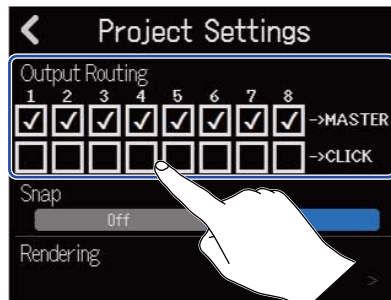

1. Tap the Output Routing boxes on the Project Settings Screen (→ [Opening the screen where various project settings can be made](#)).

Set the output destination for each track to MASTER or CLICK.



- MASTER: The sound is output from both the OUTPUT and PHONES jacks.
- CLICK: The sound is output only from the PHONES jack, and the volume balance between the MASTER and CLICK output signals can be adjusted.

NOTE:

Set  to PHONES to output the CLICK signal from the PHONES jack, and use  to adjust the volume balance with the MASTER output.

Adjusting the volume balance of the MASTER and CLICK signals output to headphones

When monitoring with headphones, the volume balance between the MASTER and CLICK output signals can be adjusted.

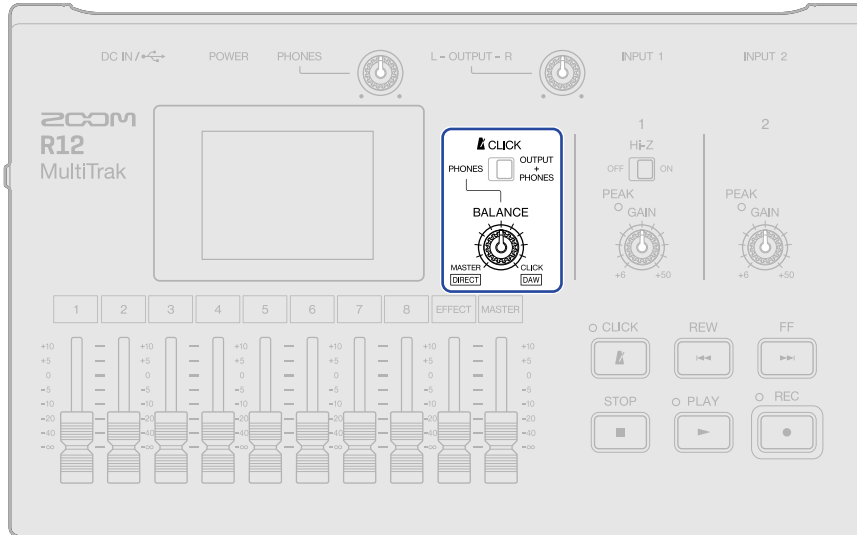

1. Set  to PHONES.

When set to OUTPUT + PHONES, the balance adjusted using the track faders is output to both the OUTPUT and PHONES jacks.

2. Turn  to adjust the balance.

- Turn right to increase the CLICK volume. When turned all the way to the right, only the CLICK will be output.
- Turn left to increase the MASTER volume. When turned all the way to the left, only the MASTER will be output.

Changing the snap setting

The snap setting used for the entire project can be changed.

If this is “On”, notes and regions will be aligned to ruler increments when moved (→ [Control Bar overview](#)).

1. Tap “On” or “Off” for “Snap” on the Project Settings Screen (→ [Opening the screen where various project settings can be made](#)).

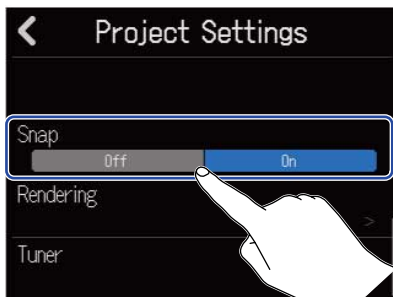

Setting	Explanation
Off	This turns off the snap function.
On	This turns on the snap function.

Using the tuner

Use the tuner function to tune guitars and other instruments.

1. Tap “Tuner” on the Project Settings Screen (→ [Opening the screen where various project settings can be made](#)).

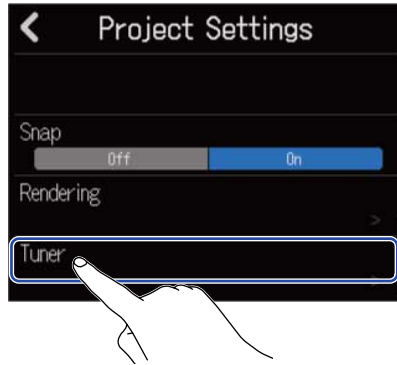

This opens the Tuner Screen.

2. On the Input Routing Screen, select the input that is connected to the guitar, bass or other instrument that you want to tune (→ [Enabling tracks for recording](#)).
3. Play the open string that you want to tune and adjust its pitch. The pitch detuning with the nearest note name or string number will be shown.

Using the chromatic tuner





Using other tuners



HINT:

-  can also be tapped on the patch memory Edit Screen to open the Tuner Screen. (→ [Opening the patch memory Edit Screen](#))
 - On the Tuner Screen, the type can be selected (→ [Selecting the tuner type](#)), the standard pitch can be changed (→ [Setting the standard pitch of the tuner](#)) and flat tunings can be selected (→ [Using flat tunings](#)).
-

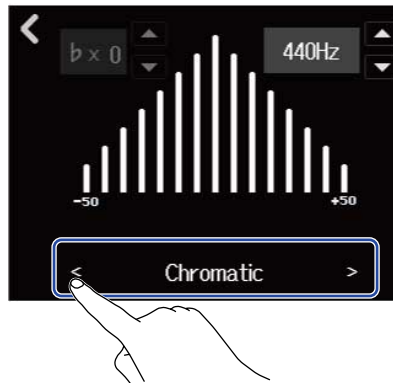

Selecting the tuner type

1. Tap  or  on the Tuner Screen (→ [Using the tuner](#)).



Display	Explanation	String number/note						
		7	6	5	4	3	2	1
Chromatic	The name of the nearest note (in semitones) and the amount of detuning are shown.	-	-	-	-	-	-	-
Guitar	Standard guitar tuning with a 7th string	B	E	A	D	G	B	E
Bass	Standard bass guitar tuning with a 5th string	-	-	B	E	A	D	G
Open A	Open A tuning (open strings play A chord)	-	E	A	E	A	C#	E
Open D	Open D tuning (open strings play D chord)	-	D	A	D	F#	A	D
Open E	Open E tuning (open strings play E chord)	-	E	B	E	G#	B	E
Open G	Open G tuning (open strings play G chord)	-	D	G	D	G	B	D
DADGAD	Alternate tuning often used for tapping and other techniques	-	D	A	D	G	A	D

Setting the standard pitch of the tuner

1. Tap  or  on the Tuner Screen (→ [Using the tuner](#)).

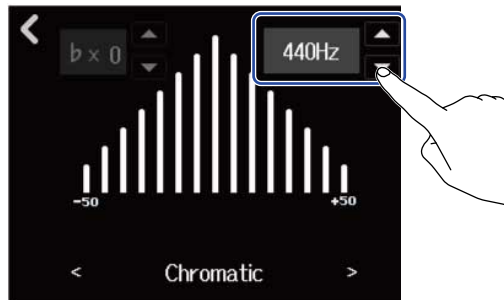



NOTE:

This can be set from 435Hz to 445Hz.

Using flat tunings

All strings can be tuned down from standard tuning by 1–3 semitones.

1. Tap  or  on the Tuner Screen (→ [Using the tuner](#)).

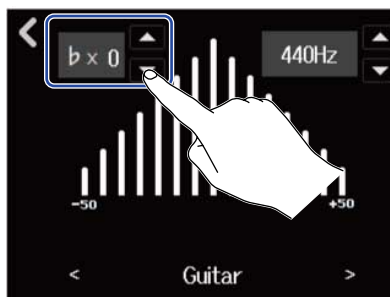

NOTE:

- This can be set from $\times 0$ to $\times 3$ (3 semitones lower).
- Flat tuning cannot be used when the tuner type is CHROMATIC.



Recording

Recording process



Prepare before recording

- Insert a microSD card (→ [Inserting microSD cards](#))
- Connect mics, instruments and other sources to inputs (→ [Connecting input devices](#))
- Turn the power on (→ [Turning the power on](#))
- Create a new project (→ [Creating new projects](#)) or open a project (→ [Opening projects](#))
- Make input settings (→ [Adjusting input levels](#), → [Making track settings](#))

Record

- Select tracks to record (→ [Enabling tracks for recording](#))
- Press  to start recording, and press  to stop it (→ [Recording](#))

Play back and check

- Press  to start playback and  to stop it
- Mix down the project (→ [Mixing projects](#))

Making input settings

Connecting input devices

Connect the devices that you want to record. Mics, guitars, basses, synthesizers and other instruments can be connected.

■ Connecting mics

Connect dynamic and condenser mics to INPUT 1 and 2 using mic cables with XLR connectors.

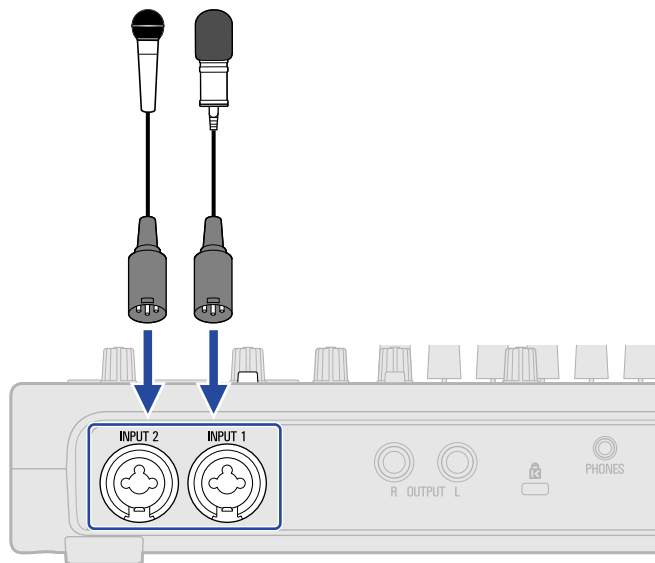

INPUT 1 and 2 support phantom power (+48V).

When connecting a condenser mic that requires phantom power, turn phantom power on ([Enabling tracks for recording](#)).

NOTE:

When connecting devices that are not compatible with phantom power, do not turn phantom power on. Doing so could damage the device.

HINT:

Phantom power is a function that supplies power to devices that require an external power supply, including some condenser mics.

+48 V is common.

■ Connecting guitars, basses and other instruments

Guitars, basses, synthesizers and other electronic instruments can be connected to INPUT 1 and 2 using cables with standard 1/4-inch plugs.

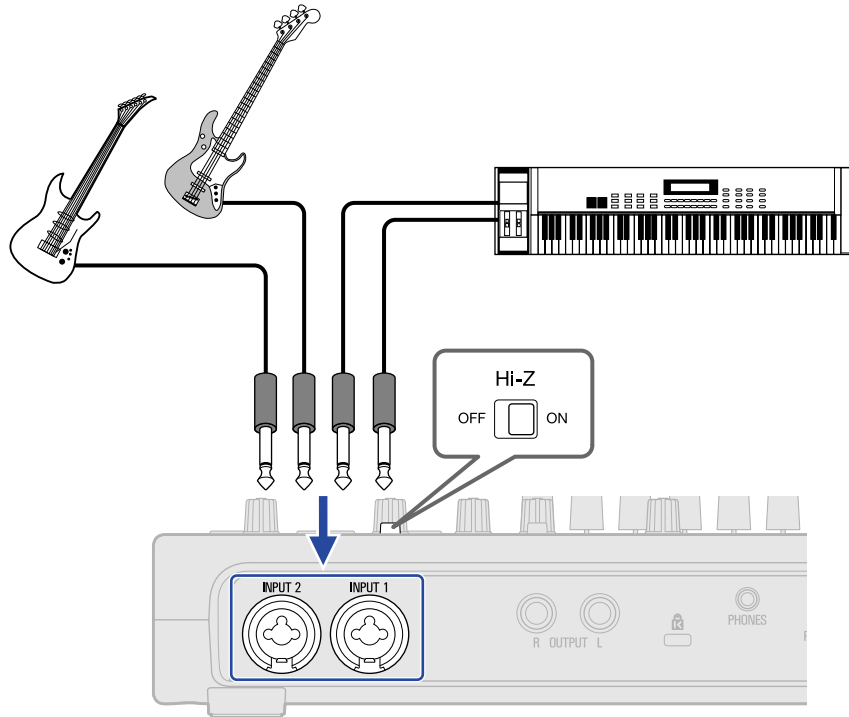

When directly connecting a guitar or bass with passive pickups, use INPUT 1 and set OFF ON to ON.

Enabling tracks for recording

Tracks can be selected for recording.

- When an audio track is selected, the sound input through the corresponding INPUT jack will be recorded.
- When a synthesizer track is selected, MIDI data input using a MIDI keyboard, for example, will be recorded.

Track types can be checked on the [Track View Screen](#).

1. Tap  on the Home Screen (Track View Screen/Level Meter View Screen).

[Track View Screen](#)







[Level Meter View Screen](#)

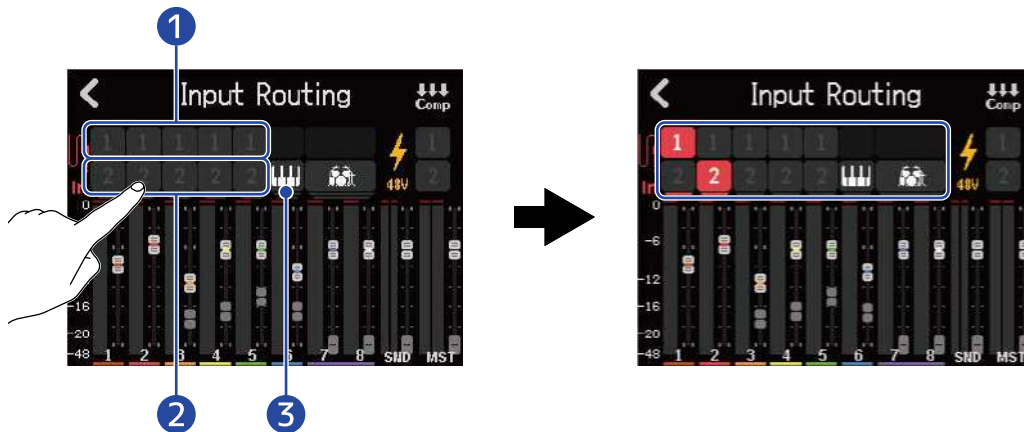

This opens the Input Routing Screen.

2. Tap tracks to select them for recording.



- 1 Sound recorded from INPUT 1
 lights on the track that will be recorded.
- 2 Sound recorded from INPUT 2
 lights on the track that will be recorded.
- 3 Performance recorded from a MIDI keyboard
 will light red.

NOTE:

Recording to rhythm tracks is not possible.

3. Tap the phantom icons for inputs that have condenser mics that require phantom power connected to them.

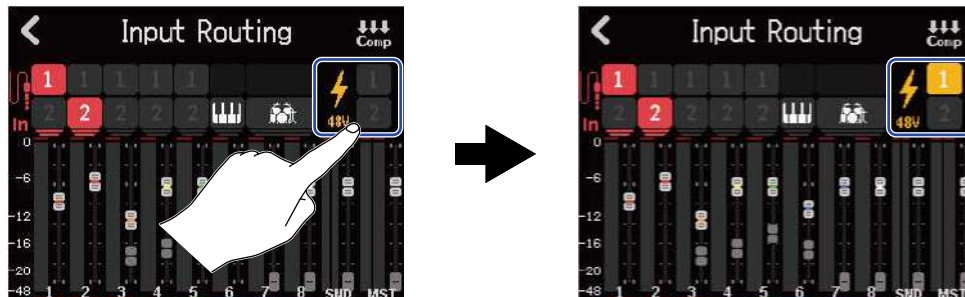

Tapped input icons will light, showing that the phantom setting is on.

4. Tap .

The Home Screen will reopen.

On the Track View Screen, the numbers of the tracks armed for recording are shown with red backgrounds. On the Level Meter View Screen, the tracks armed for recording inputs are shown along with the input phantom power settings.

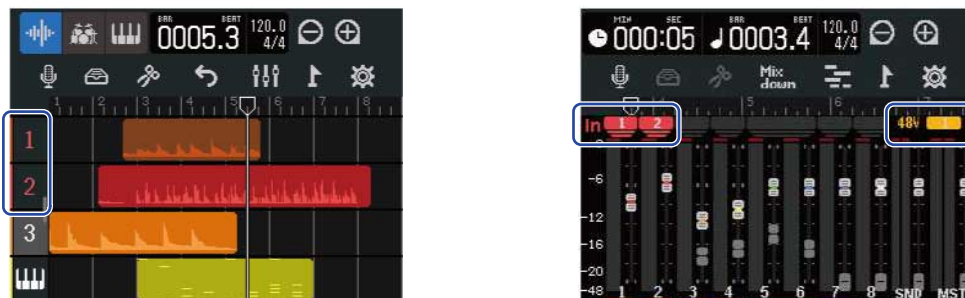
**NOTE:**

- The input signals selected this way will also be sent to the MASTER tracks.
- By connecting a MIDI keyboard, for example, synthesizer track performances can be recorded. (→ [Using MIDI keyboards](#))
- 2 inputs can also be assigned to 1 track. (They will be mixed together in mono.)

HINT:

Two adjacent tracks can be set to be a stereo track. (→ [Enabling stereo linking](#)) In this case, the odd-numbered track of the stereo-linked pair will be assigned to INPUT 1 and the even-numbered track will be assigned to INPUT 2.

Adjusting input levels

The levels of signals input to the R12 can be adjusted.

1. Turn  for INPUT 1 and 2 to adjust their input levels.

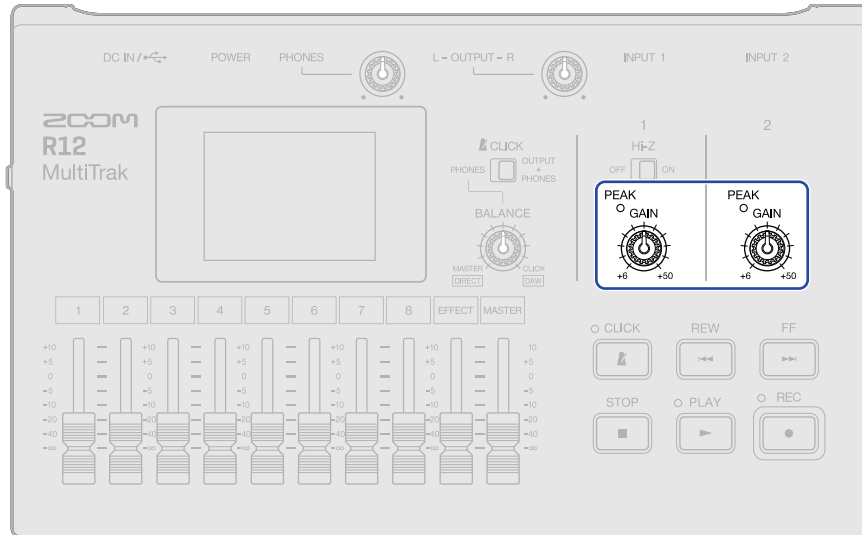

Adjust them so that their PEAK indicators do not light.

HINT:

- If the sound distorts even after lowering the input level, try changing mic positions and adjusting the output levels of connected devices.
- The Comp/Limiter/Gate function can also be used to adjust levels. (→ [Using the Comp/Limiter/Gate function](#))

Using the Comp/Limiter/Gate function

The volume can be adjusted suitably according to input signal levels and unwanted noise can be cut, making the sound clearer.

- **Comp**
The compressor reduces level differences between loud and quiet sounds, making the sound clearer.
- **Limiter**
The limiter can prevent distortion by reducing input signals that have high levels.
- **Gate**
This cuts input signals with low levels, reducing background noise.

The compressor and limiter lower input signals with high levels according to the parameter adjustments shown below. The limiter has a stronger effect compared to the compressor. The gate cuts input signals with low levels according to the parameter adjustments shown below.

Comp/Limiter

Gate

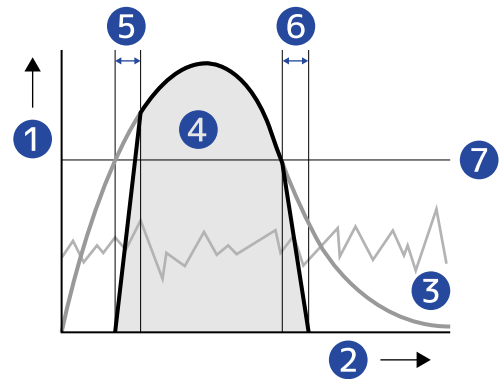
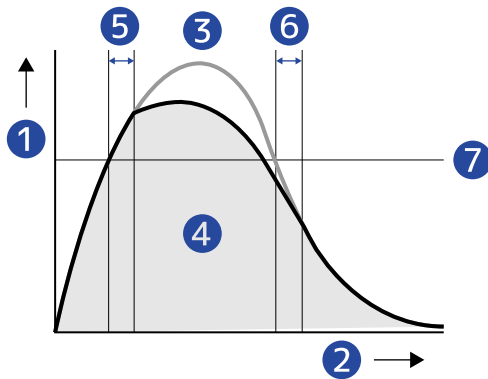

- 1 Level
- 2 Time
- 3 Original signal
- 4 Output signal when Comp/Limiter/Gate used
- 5 Attack Time
- 6 Release Time
- 7 Threshold

Parameter	Explanation
Threshold	<p>Comp/Limiter: This adjusts the input level that activates the effect. When the input level exceeds the threshold, the excess level is compressed with a ratio of 1:4 for Comp and 1:20 for Limiter.</p> <p>Gate: This adjusts the input level that deactivates the effect. Sound below the threshold level will not be output.</p>
Attack Time	<p>Comp/Limiter: This adjusts the speed that the effect is activated after the input signal exceeds the threshold level.</p> <p>Gate: This adjusts the speed that the effect is deactivated after the input signal exceeds the threshold level.</p>
Release Time	<p>Comp/Limiter: This adjusts how quickly the effect is deactivated after the input signal goes below the threshold level.</p> <p>Gate: This adjusts the speed that the effect is activated after the input signal goes below the threshold level.</p>

NOTE:

Comp/Limiter/Gate settings can be changed during recording and playback.

1. Tap  on the Home Screen (Track View Screen/Level Meter View Screen).

Track View Screen



Level Meter View Screen



This opens the Input Routing Screen.

2. Tap .

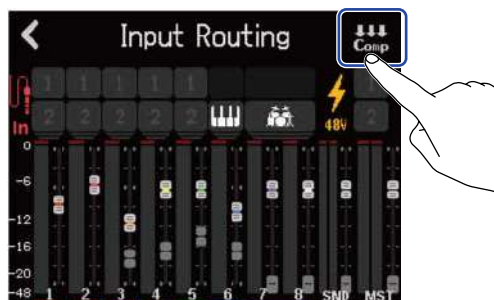

3. Tap ◀ and ▶ to select an input for setting the Comp/Limiter/Gate function.

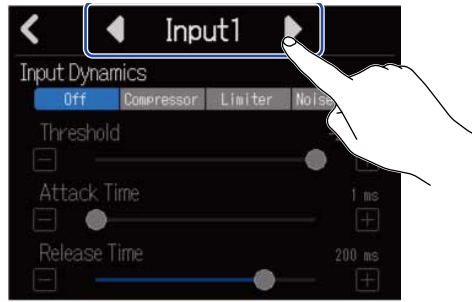

Select "Input 1" or "Input 2".

HINT:

Comp/Limiter/Gate settings can be made separately for each input.

4. Tap the desired setting.

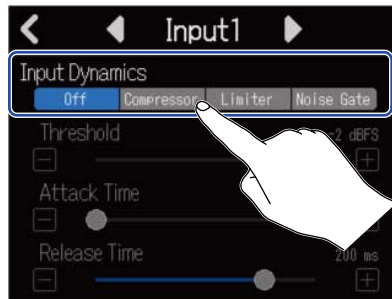

Setting	Explanation
Off	This turns the Comp/Limiter/Gate off. No settings can be made from step 2.
Compressor	This selects the compressor. The ratio is 4:1.
Limiter	This will apply the limiter The ratio is 20:1.
Noise Gate	This will apply the noise gate.

5. Slide the Threshold slider or tap  and  to adjust the threshold level.

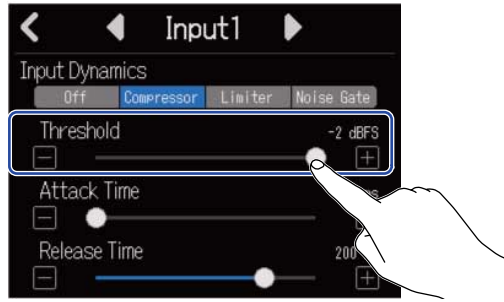

HINT:

This can be set from -16 to -2 dBFS for the compressor and limiter.
This can be set from -80 to -2 dBFS for the noise gate.

6. Slide the Attack Time slider or tap  and  to adjust the attack time.

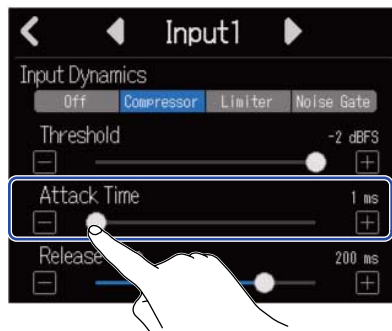

HINT:

This can be set from 1 to 4 ms.

7. Slide the Release Time slider or tap  and  to adjust the release time.

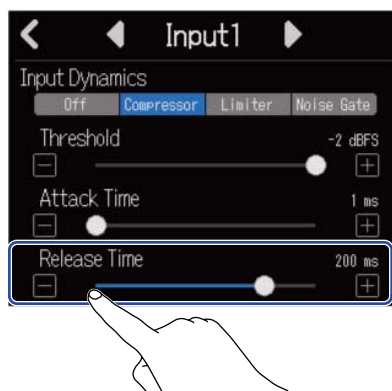

HINT:

This can be set from 1 to 500 ms.

Making track settings

Settings can be made for tracks to be recorded.

Track types can be selected, EQ, spatial and distortion effects can be adjusted, monitor panning can be set and send effects can be adjusted.



In addition, two adjacent tracks can be stereo-linked and used as a stereo track.

Setting track types

Track types can be set to audio, rhythm or synthesizer.

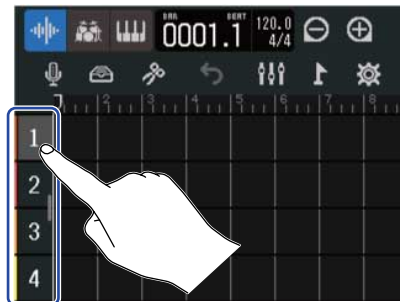

1. Tap the header for the track you want to set the type for.



2. Tap ,  or  in the Control Bar.



When set as a rhythm or synthesizer track, the track number will be replaced with a rhythm or synthesizer track icon.

Setting	Explanation
 Audio track	Sound input through an INPUT jack can be recorded and played back. WAV files can also be imported from microSD cards and USB flash drives and placed as regions.
 Rhythm track	Rhythm loops included in the R12 can be placed and played back. (→ Using internal rhythm loops)
 Synth track	MIDI data can be input and MIDI files from microSD cards and USB flash drives can be placed as regions and used with the synthesizer sound source in the R12. MIDI data performed on a MIDI keyboard can be recorded and played back. (→ Using the synthesizer)

NOTE:

Each project can only have one set synthesizer track. If a synthesizer track already exists and has a region, a new synthesizer track cannot be set.

Opening Track Settings Screens

On Track Settings Screens, EQ and send effects can be adjusted, and monitor panning and stereo links can be set.

1. Double-tap the header for the track that you want to set.



2. Tap "Track Settings".

This opens the Track Settings Screen.

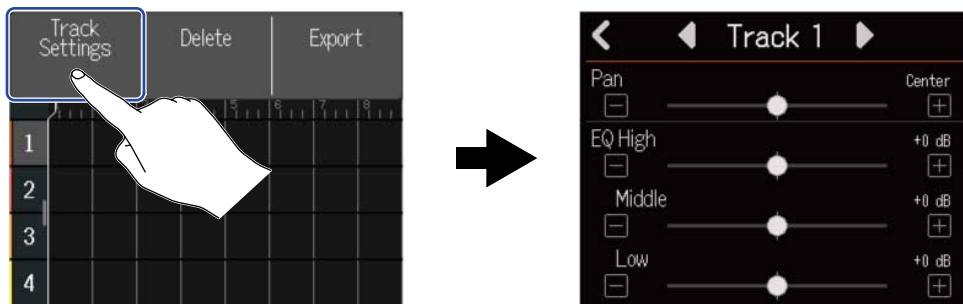

HINT:

- Tap ◀▶ at the top of the screen to open the screen for an adjacent track.



- Stereo-linked tracks are shown with track names like "Track 1/2".

Adjusting panning for monitoring

The left-right panning of each track can be adjusted when monitoring input signals through headphones or powered monitors.

1. On a Track Settings Screen (→ [Opening Track Settings Screens](#)), slide the Pan slider or tap  / .

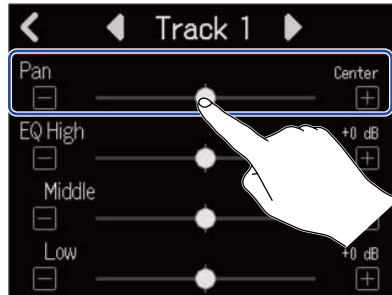

NOTE:

- The setting range is L100 (left) – Center – R100 (right).
- This panning adjustment only affects the monitoring signal. It has no effect on individual track recording data.
- These settings are saved separately for each recorded project. This can also be changed during playback.

Adjusting EQ

The amount of boost/cut can be adjusted for each frequency band.

1. On a Track Settings Screen (→ [Opening Track Settings Screens](#)), slide the EQ Low, Middle and High sliders or tap  / .

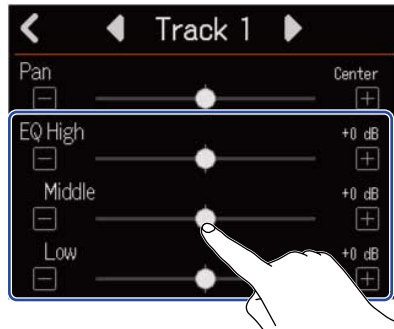

■ High

This adjusts the boost/cut of high-frequency equalization.

- Type: shelving
- Gain range: -12 dB - +12 dB
- Frequency: 10 kHz

■ Middle

This adjusts the boost/cut of mid-frequency equalization.

- Type: peaking
- Gain range: -12 dB - +12 dB
- Frequency: 2.5 kHz

■ Low

This adjusts the boost/cut of low-frequency equalization.

- Type: shelving
- Gain range: -12 dB - +12 dB
- Frequency: 100 Hz

Enabling stereo linking

Two adjacent tracks (1 and 2 or 3 and 4, for example) can be set as a stereo track. This enables those inputs to be handled as a stereo sound. This will record the tracks as stereo data, which is convenient when editing, for example. (Stereo Link function)

1. On a Track Settings Screen (→ [Opening Track Settings Screens](#)), tap “On” or “Off” for Stereo Link.



NOTE:

- If a track already has regions, stereo-linking will not be possible.
- Only audio tracks can be stereo-linked.

Using effects

The R12 has effects that are equivalent to those in ZOOM multi-effects processors. In addition to reverb, delay and other individual effects, patch memories that contain up to three effects can also be selected. By selecting effects and patch memories, a variety of effects can be applied to instruments, voices and other sound sources.

Using the free Guitar Lab effect management application on a computer (Mac/Windows), you can add effects that are distributed online as well as edit and back up patch memories, for example.

Effects can be used in the following two ways.

- **Send effect**

The input or playback sounds from individual tracks are sent to this effect. The sound with the effect applied is output through the PHONES and OUTPUT jacks, so it can be checked through headphones or powered monitors. The amount the effect is applied can be adjusted by setting the level sent to the effect (send level).

Reverb, delay and other individual effects, as well as patch memories, can be selected. When a patch memory is selected, insert (input) effects cannot be used.

The send effect does not affect recording data, but it does affect mixdown data.

This effect can be applied to multiple tracks, allowing it to be used, for example, to add reverb to every track.

- **Insert (input) effect**

This effect is applied directly to the track, so it does affect recording data.

This can be selected from the patch memories.

Use this to record a guitar with distortion, for example.

The insert (input) effect can only be used on one track.

NOTE:

If a patch memory has been selected for the send effect, an insert (input) effect cannot be used.

Using send effects

The send levels for signals sent to the effect can be adjusted for all tracks. The higher the send level the greater the effect.

1. Tap "Send Effect" on a Track Settings Screen (→ [Opening Track Settings Screens](#)).



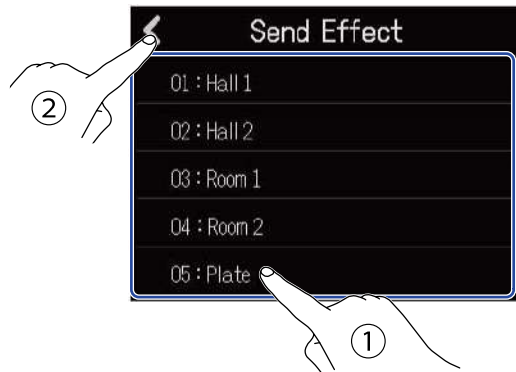

2. On the Send Effect Screen, select an effect (①), and tap  (②).



This reopens the Track Settings Screen.

HINT:

Patch memories can be used by selecting "Patch Memory" on the Send Effect Screen. Tap this to open the Effect Screen. Then, select the desired patch memory and tap . See [Editing patch memories](#) for details about how to edit patch memories.

3. Slide the Send Level slider or tap  and .

This adjusts the send level for the selected track.



4. Slide the Send Effect sliders to adjust the effect.

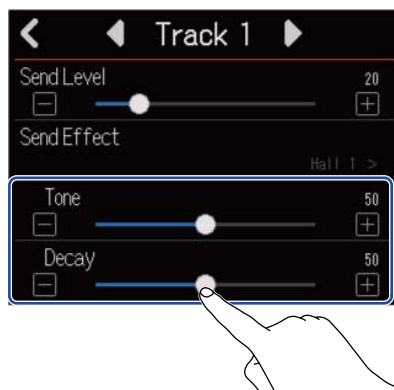

The parameters that can be adjusted depend on the effect selected in step 2.

If "Patch Memory" was selected in step 2, the effect adjustment sliders will be disabled and appear gray.

5. Use the EFFECT fader to adjust the effect level of all tracks.

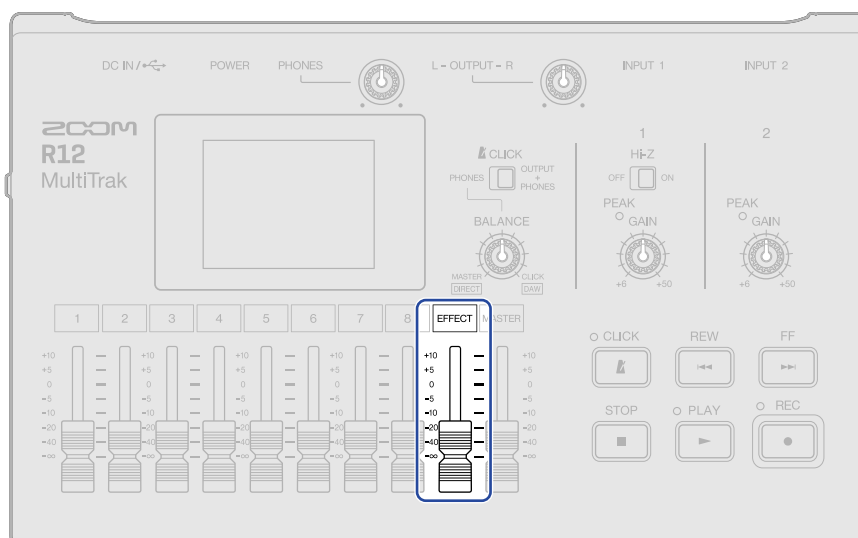

NOTE:

To record affected sounds, use insert (input) effects.

Using insert (input) effects

1. Tap a Track Header on the [Track View Screen](#) to select the audio track to which the insert (input) effect will be assigned.



NOTE:

Effects can only be used on audio tracks.

2. Tap  in the Control Bar.

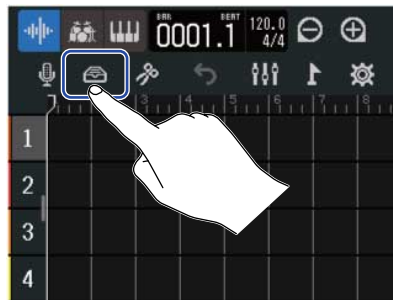

3. On the Effect Screen, select a patch memory (①), and tap  (②).

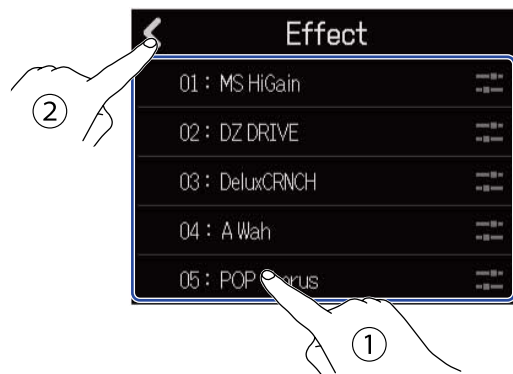

The Track View Screen will reopen.

HINT:

See [Editing patch memories](#) for details about how to edit patch memories.

Editing patch memories



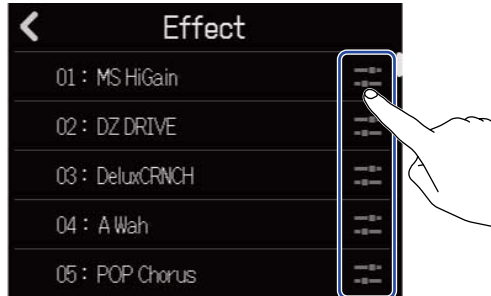

Opening the patch memory Edit Screen

1. On the Effect Screen, tap  for the patch memory you want to edit.

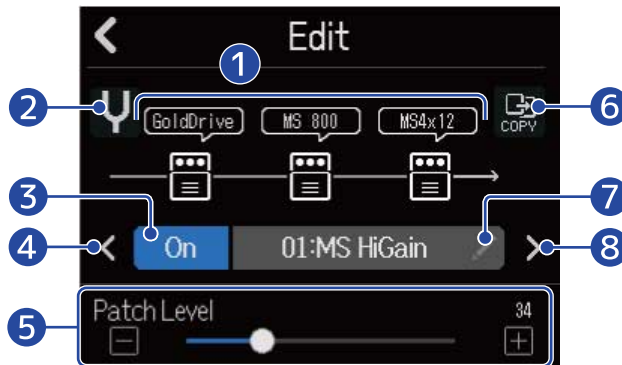

This opens the patch memory Edit Screen.



- 1 **Effects used**
Tap these to adjust the parameters of the effects. (→ [Adjusting effect parameters](#))
- 2 **Tuner button**
Tap this to use the tuner. (→ [Using the tuner](#))
- 3 **Patch memory On/Off button**
Tap this to turn the patch memory on/off.
 - On: 
 - Off: 
- 4 **Select previous patch memory**
- 5 **Adjust patch memory volume**
Slide the slider or tap  and  to adjust the patch memory volume.
- 6 **Copy button**
Use this to copy the settings of the current patch memory to another one. (→ [Copying patch memories](#))

7 Patch memory name edit button

Tap this to open the Character Input Screen. See [Character Input Screen overview](#) for editing procedures.

8 Select next patch memory

HINT:

The content of edited patch memories will be saved automatically.

Turning patch memories on/off

- 1.** Tap "On" or "Off" on the patch memory Edit Screen (→ [Opening the patch memory Edit Screen](#)).

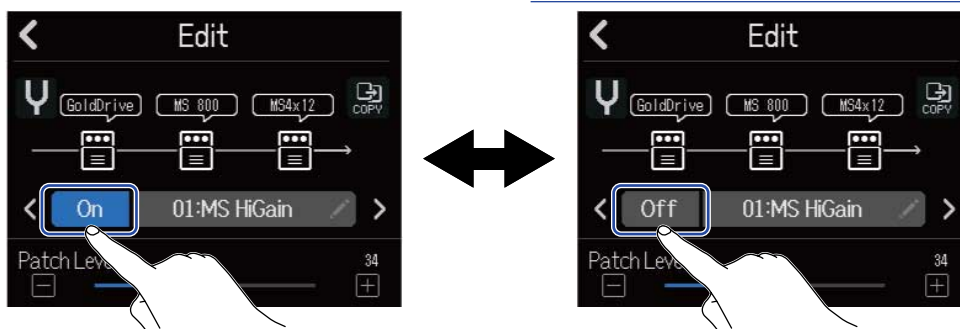

Adjusting effect parameters

1. Tap the effect you want to edit on the patch memory Edit Screen (→ [Opening the patch memory Edit Screen](#)).

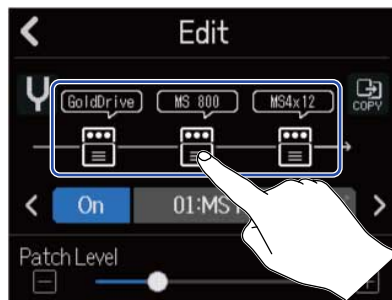

This opens the Effect Settings Screen.

2. Adjust the effect.



- 1 Return to the patch memory Edit Screen

- 2 Replace effects

Tap this to open the Effect List Screen. Then, tap the desired effect to select it.

- 3 Effect on/off

Tap this to turn the effect on/off.

- 4 Effect adjustment parameters

Slide the patch memory sliders or tap  and  to adjust the parameters.

NOTE:

- Three effects can be combined as desired in a patch memory. If the processing capability limit is exceeded, however, a “Process Overflow” warning will appear and effects will be bypassed. Change one of the effects to end this condition.
- The parameters that can be adjusted depend on the effect.

Copying patch memories

Patch memory changes are saved automatically. To save the original patch before changing it, copy it to an empty patch memory.

1. Tap  on the patch memory Edit Screen (→ [Opening the patch memory Edit Screen](#)).

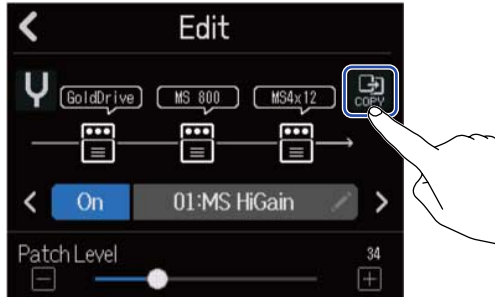

This opens a patch memory list.

2. Tap the name of the copy destination patch memory.

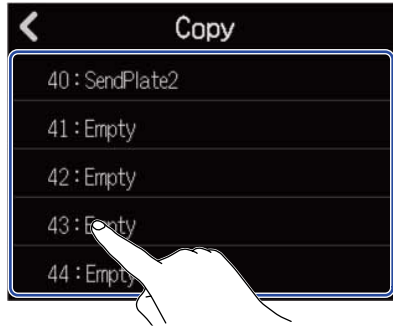

3. Tap "Execute".

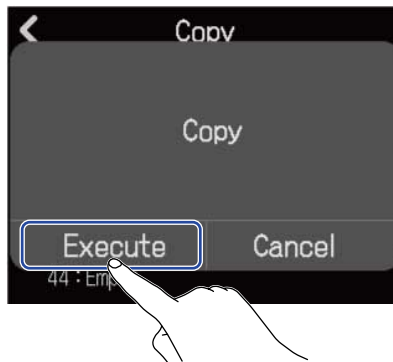

NOTE:

Patch memories are not saved in projects. 50 patch memories can be saved as R12 settings.

Changing patch memory names

1. Tap  on the patch memory Edit Screen (→ [Opening the patch memory Edit Screen](#)).

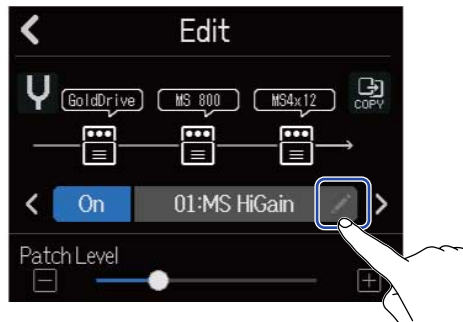



This opens the Character Input Screen.

2. Input the patch memory name.
See [Character Input Screen overview](#) for how to input characters.



3. When "Done" appears, tap "Close".
This changes the patch memory name and returns to the previous screen.

Changing patch memory levels

1. On the patch memory Edit Screen (→ [Opening the patch memory Edit Screen](#)), slide the “Patch Level” slider or tap  and .

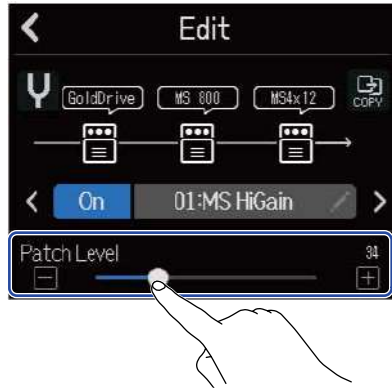



NOTE:

This can be set from 0 to 120.

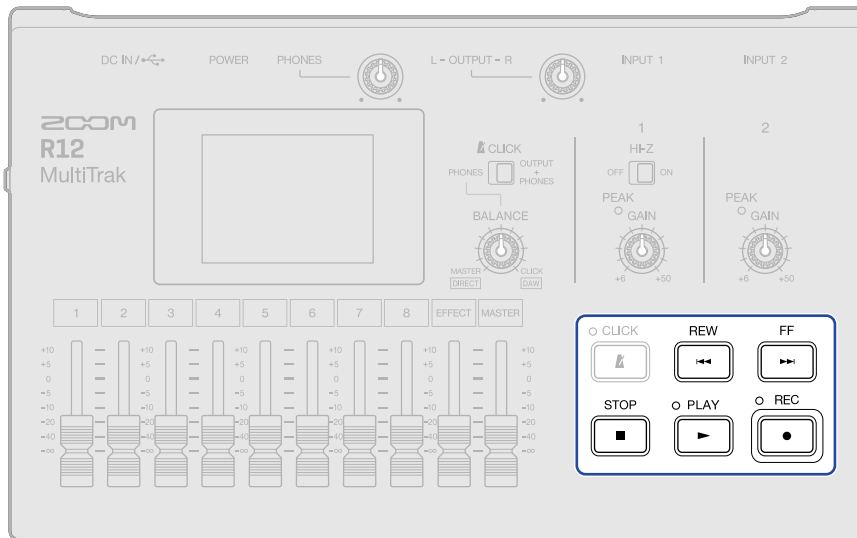
Recording



1. Press  when the Track View Screen or Level Meter View Screen is open.

This starts recording from the current playback position. The  indicator lights during recording.

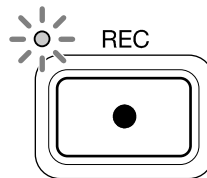







Pressing  when a screen other than the Track View Screen or Level Meter View Screen is open will open one of those screens.

2. Press  to stop.

NOTE:

- A project can have a maximum of 1350 bars. Recording will stop automatically if it reaches this length.
- Recording is not possible if the microSD card does not have open space.

HINT:

- Pressing  during playback will start recording from that point.
 - See [Using the synthesizer](#) for information about recording synth tracks.
 - Even when recording, the Screen Switching buttons () can be tapped to switch to the [Track View Screen](#) and [Level Meter View Screen](#). (→ [Control Bar overview](#))
 - Press  +  to move to the next marker or  +  to move to the previous marker. (→ [Using markers](#))
 - If undo is used with recording, the playback position will return to the recording start position. If redo is used, the playback position will return to the recording end position. (→ [Control Bar overview](#))
-

Using internal rhythm loops

The R12 includes rhythm loops for various genres.

By setting the track type to rhythm, drum patterns and other rhythm loops can be assigned to it as desired and played back.

1. Tap the track on which you want to place a rhythm loop on the [Track View Screen](#). This highlights the tapped track.



2. Tap .

This changes the track tapped in step 1 to a rhythm track.





NOTE:

Rhythm tracks are stereo tracks.

3. Tap  in the Control Bar.



This opens the Rhythm Loops List.

4. Tap  to preview rhythm loops.
The selected rhythm loop will play back.
Tap  again to stop playback.

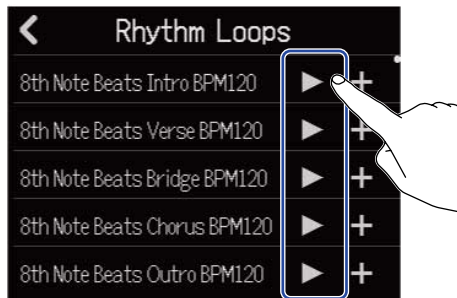

5. Tap  for the rhythm loop you want to add.
The selected rhythm will be added to the rhythm track.

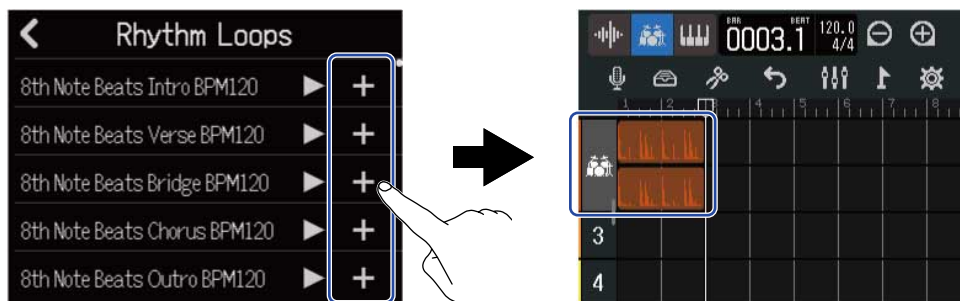

NOTE:

- The rhythm loop will be added to the selected track from the playback position.
- Rhythm loops are automatically synchronized with the set tempo of the project when added. (→ [Changing project tempos](#))

■ Rhythm loops

The R12 has Intro, Verse, Bridge, Chorus and Outro sections for the following rhythm loops.

Genre	BPM	Genre	BPM
8th Note Beats	120	Bounce Pop	85
16th Note Beats	108	Modern R&B	75
4th Note Beats	168	Neo Soul	90
Pop Rock	136	Modern 80's	100
Retro Rock	110	80's Pop	118
Hard Rock	80	Synthpop	120
Punk Rock	130	Big Room House	128
Funk Rock	95	Tech House	125
Britpop	80	Dubstep	140
Indie Pop	100	Electro Trap	70
Indie Disco	120	Trap	70
Indie Rock	100	Boom Bap	85
Garage Rock	150	Latin Percussion	95
Funky Soul	90	Pop Percussion	110
16feel Pop	90	Street Live Percussion	90

Using the synthesizer

The R12 includes various synthesizer sounds.

By connecting a USB MIDI keyboard (sold separately) to the R12, the keyboard can be played to record the selected synthesizer sound. (→ [Using MIDI keyboards](#))

Selecting the synth sound

1. On the [Track View Screen](#), tap the track you want to record the synth on.
This highlights the tapped track.

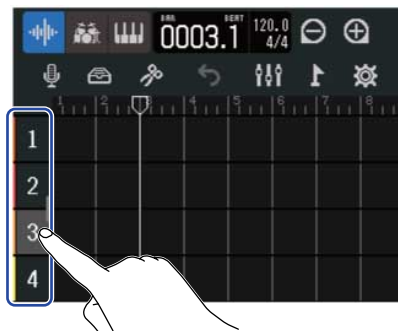

2. Tap .

This makes the track tapped in step 1 into the synth track.



3. Tap .



This opens the Synth List.

4. Tap  to check the sound of a synth.

This will open a keyboard. Tap the keys to play the sound.

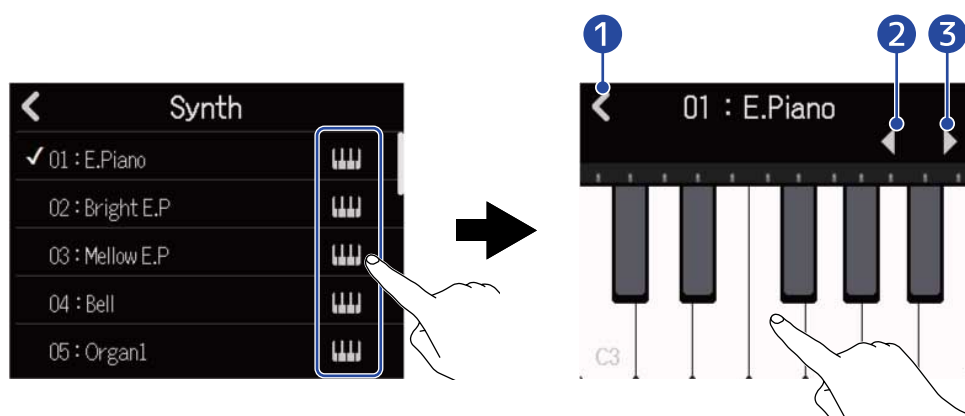

- 1 Return to the previous screen.
- 2 Lower the octave.
- 3 Raise the octave.

HINT:

- Note names are shown on every C of the keyboard (every octave).
- Up to 8 notes can be output at a time (8-voice polyphony).
- The range is C0-E8.
- When notes are output, the red indicators above the keyboard light.

5. Tap a synth name to select it.

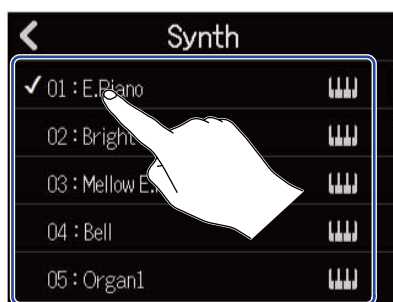

The tapped synth will be selected.



The R12 has the following synth sounds.

E.Piano	Organ2	Slap Bass	Brass2
Bright E.P	Pipe Organ	AcousticBass	Brass3
Mellow E.P	Finger Bass1	Synth Bass1	Synth Lead
Bell	Finger Bass2	Synth Bass2	Drum Kit
Organ1	Pick Bass	Brass1	

Recording

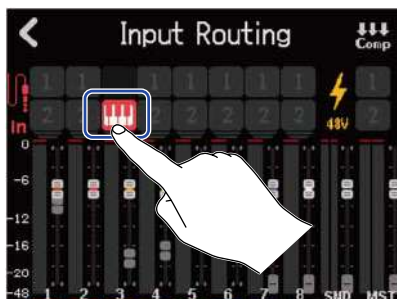
1. Referring to [Using MIDI keyboards](#), connect a MIDI keyboard to the R12.
2. Tap  on the Input Routing Screen so that it lights red (→ [Enabling tracks for recording](#)).



3. Press .
Recording will start from the current playback position.
4. Play the MIDI keyboard.
The MIDI keyboard performance will be recorded as MIDI data on the synth track.
5. Press  to stop.

HINT:





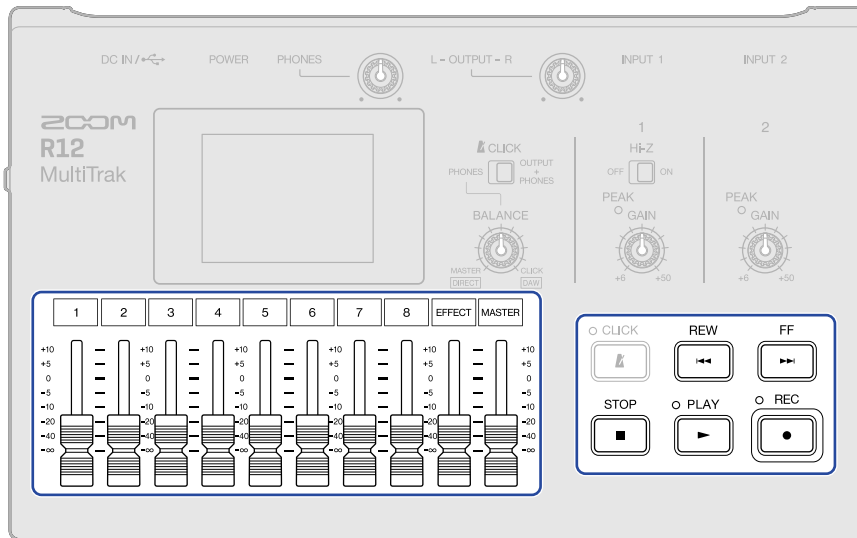





Notes can also be input using the touchscreen instead of using a MIDI keyboard. (→ [Editing notes \(synth regions\)](#))

Playing projects



1. Press .

Button operations during playback

- Search backward/forward: Press and hold  / 
- Move playback position forward/backward: Press  / 
- Stop: Press  or .
- Return to beginning: Press  when stopped
- Adjust track volume: Move channel fader
- Adjust master track volume: Move MASTER fader
- Adjust send effect volume: Move EFFECT fader
- Move to previous/next marker: Press  +  /  + 

Touchscreen operations during playback

- Zoom out/in horizontally:

Tap  to zoom out on the timeline display. (This enables showing many bars at the same time.)



Tap  to zoom in on the timeline display. (This enables displaying more detail.)

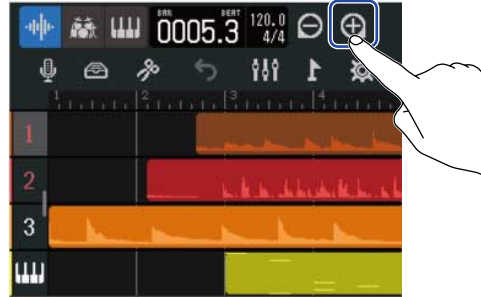

- Move playback position: Slide playback position left/right or tap the ruler.



Editing projects

Recorded audio data and notes can be edited by region. For example, regions can be moved, deleted, copied, pasted, looped and split.

With waveform editing, audio regions can be stretched without changing pitch and unnecessary parts can be deleted.

With MIDI note editing, notes can be added and deleted as well as be adjusted for length and velocity, for example.

Markers can also be added to the Ruler in the Control Bar. Markers can be used to make identifying the overall structure of a song easier and are convenient when editing and mixing down.

Editing regions

Use the [Track View Screen](#) to move, delete, copy, paste, loop, split and otherwise edit audio and synth regions.

Moving regions

Regions can be moved forward and backward on the timeline and to different tracks.

1. On the [Track View Screen](#), tap the region you want to move.
This highlights the selected region.

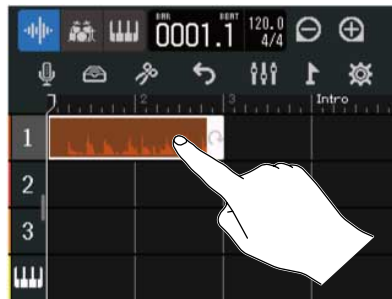

2. While still touching the selected region, drag it to the desired position.

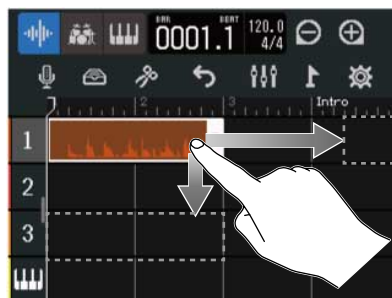

HINT:

If the snap function is on, it will be aligned to a ruler increment when moved. (→ [Changing the snap setting](#))

■ Moving multiple regions simultaneously

1. On the [Track View Screen](#), double-tap a region that you want to move.



This highlights that region and opens the Option Menu at the top of the screen.

2. Tap "Select".

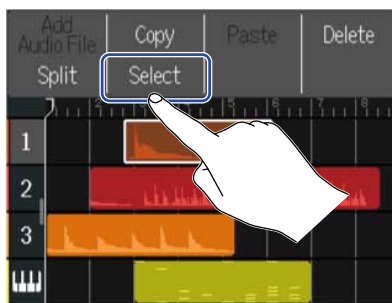

3. Tap the other regions that you want to move.
The selected regions will be highlighted.

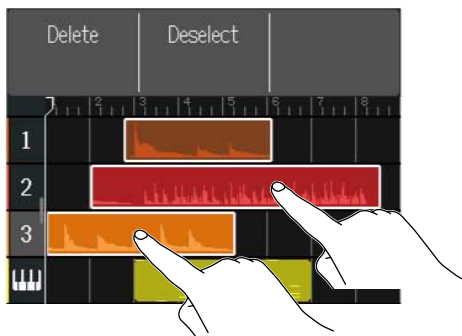

Tapping a selected region will deselect it.

4. Drag the selected regions to the desired position.



Tap "Deselect" to return to the previous screen.

Looping regions

Regions can be looped (played back repeatedly).

1. On the [Track View Screen](#), tap the region you want to loop. This highlights the selected region.



2. Drag the right edge of the region.



Dragging right will increase the number of loops, while dragging left will decrease the number.

Creating empty synth track regions (synth track only)

Regions can be created for adding MIDI notes manually. (→ [Editing notes \(synth regions\)](#))

1. On the [Track View Screen](#), double-tap an area with no region on the synth track.



The Option Menu will open at the top of the screen.

2. Tap "Create Region".

An empty synthesizer region that is one bar long will be created at the double-tapped position.



Loading WAV files as regions

WAV files on microSD cards and USB flash drives can be loaded into projects.

NOTE:

Files with the following formats can be loaded.

- WAV files: Either 44.1kHz/16-bit or 44.1kHz/24-bit according to the project setting

1. Copy the files that you want to load onto the microSD card or USB flash drive in advance.
 - When loading from a microSD card: Put the files in the “AUDIO” folder on the microSD card. (→ [Folder and file structure on microSD cards](#))
 - When loading from a USB flash drive: Put the files in the “ZOOM_R12” > “AUDIO” folder on the USB flash drive. (→ [Folder and file structure on USB flash drives](#))

2. On the [Track View Screen](#), move the playback position to where you want to load the file.



3. Double-tap part of an audio track that has no regions.



The Option Menu will open at the top of the screen.

4. Tap "Add Audio File".



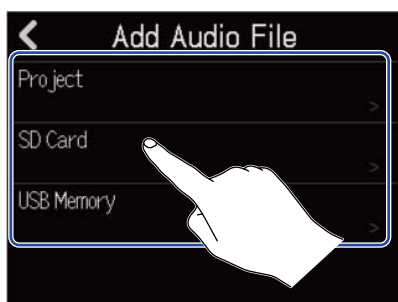

5. Tap "Project" to load from a project, "SD Card" to load from a microSD card, or "USB Memory" to load from a USB flash drive.



HINT:

When loading from a USB flash drive, connect it to the USB port. (→ [Connecting USB flash drives](#))

6. Tap  to preview the file you want to load.

This will play the selected file.  will light ().

Tap  to stop playback.

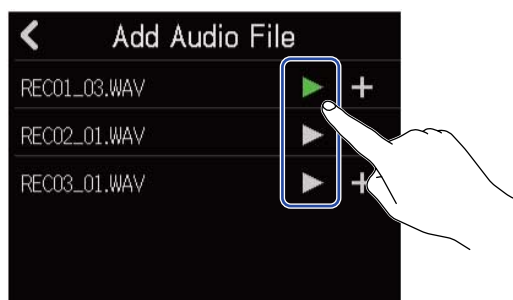

7. Tap  for the file you want to load.

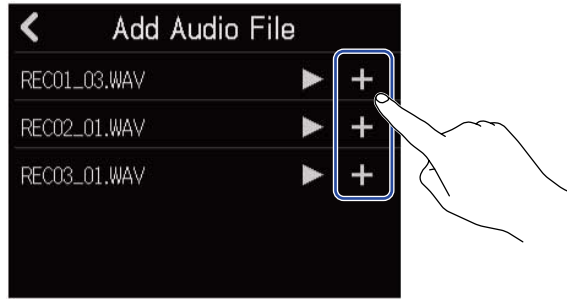

NOTE:

- An error message will appear if it cannot be loaded. Select a different file.
- Loading is not possible if the maximum number of regions in the project would be exceeded.
 - Total number of audio and rhythm regions: 50
 - Synth regions: 80

8. Input the file name of the loaded WAV file.



See [Character Input Screen overview](#) for how to input characters.

NOTE:

If "Project" was selected in step 5, the Character Input Screen will not open. Continue to the next step.

9. When "Done" appears, tap "Close".

This completes loading the track and opens the Track View Screen.

Loading MIDI files as regions

MIDI files on microSD cards and USB flash drives can be loaded into projects.

NOTE:

MIDI files with the following formats can be loaded.

- SMF (Standard MIDI File): Format 0/Format 1

1. Copy the files that you want to load onto the microSD card or USB flash drive in advance.
 - When loading from a microSD card: Put the files in the “MIDI” folder on the microSD card. (→ [Folder and file structure on microSD cards](#))
 - When loading from a USB flash drive: Put the files in the “ZOOM_R12” > “MIDI” folder on the USB flash drive. (→ [Folder and file structure on USB flash drives](#))

2. On the [Track View Screen](#), move the playback position to where you want to load the file.



3. Double-tap part of a synth track that has no regions.



The Option Menu will open at the top of the screen.

4. Tap "Add MIDI File".



5. Tap the channel in the MIDI file that you want to load.

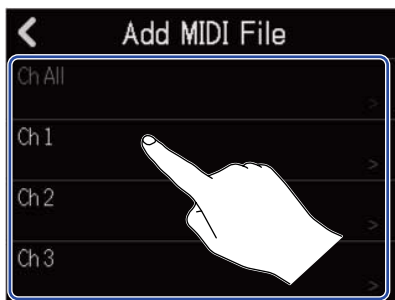

NOTE:

- This loads the notes of the selected channel.
- When loading a MIDI file that has notes on multiple channels, selecting "Ch All" will create a region with the notes from those channels on the R12 synth track. In this case, the timbre of each channel will be automatically assigned from their program change numbers.
- The notes in the synth regions that have been loaded using "Ch All" cannot be edited.
- "Ch All" cannot be selected if the synth track already has regions. Moreover, other regions cannot be added if there is a MIDI file that was loaded using "Ch All".

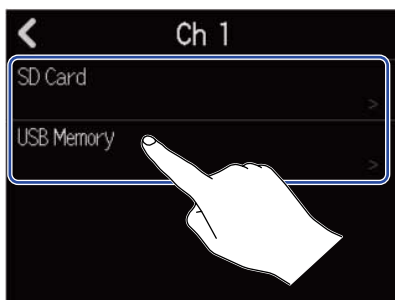

6. Tap "SD Card" to load from a microSD card, or tap "USB Memory" to load from a USB flash drive.



HINT:

When loading from a USB flash drive, connect it to the USB port. (→ [Connecting USB flash drives](#))

7. Tap  to preview the file you want to load.

This will play the selected file.  will light ().

Tap  to stop playback.

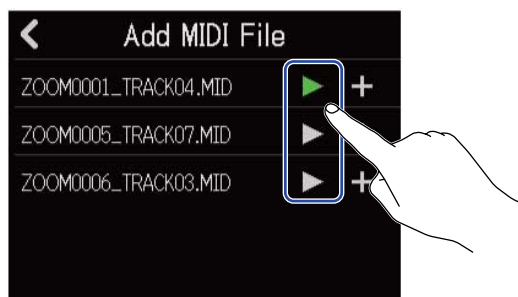

8. Tap  for the file you want to load.

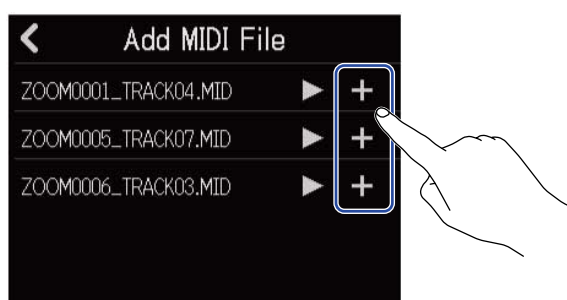

This completes loading the track and opens the Track View Screen.

NOTE:

- An error message will appear if it cannot be loaded. Select a different file.
- Loading is not possible if the maximum number of regions in the project would be exceeded.
 - Total number of audio and rhythm regions: 50
 - Synth regions: 80

Copying and pasting regions

Regions can be copied and pasted to other locations.

1. On the [Track View Screen](#), double-tap the region that you want to copy and paste.



This highlights that region and opens the Option Menu at the top of the screen.

2. Tap "Copy".



The selected region will be copied.

3. Move the playback position to where you want to paste.



4. Double-tap the track where you want to paste in an area that has no regions.



The Option Menu will open at the top of the screen.

5. Tap "Paste".

This pastes the copied region at the playback position.



The playback position will move to the end of the pasted region.

Tap anywhere else to close the Option Menu.

NOTE:

- Pasting to different tracks is possible.
- Pasting to different types of tracks is not possible.

Deleting regions

1. On the [Track View Screen](#), double-tap the region that you want to delete.



This highlights that region and opens the Option Menu at the top of the screen.

2. Tap "Delete".

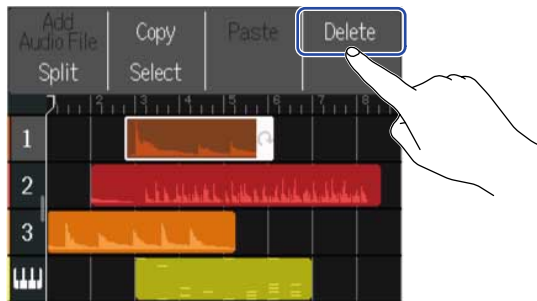

3. Tap "Execute".

The selected region will be deleted.

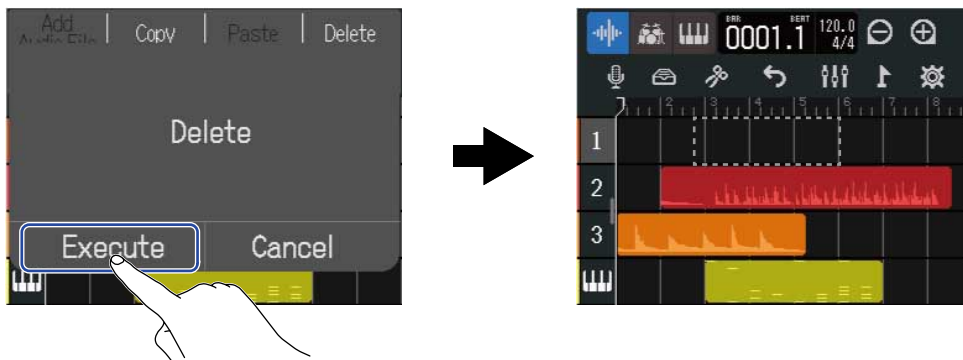

Tap "Cancel" to cancel deletion and return to the previous screen.

■ Deleting multiple regions simultaneously

1. On the [Track View Screen](#), double-tap a region that you want to delete.



This highlights that region and opens the Option Menu at the top of the screen.

2. Tap "Select".

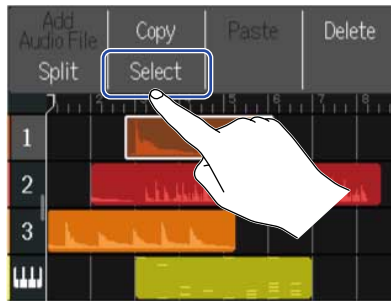

3. Tap the other regions that you want to delete.
The selected regions will be highlighted.

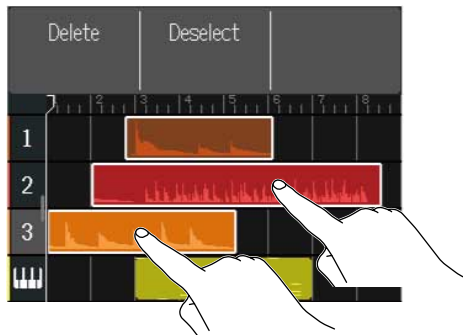

Tapping a selected region will deselect it.

4. Tap "Delete".

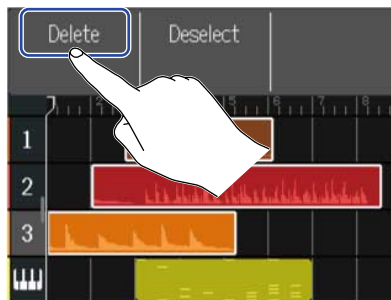

Tap "Deselect" to cancel deletion and return to the previous screen.

5. Tap "Execute".

The selected region will be deleted.

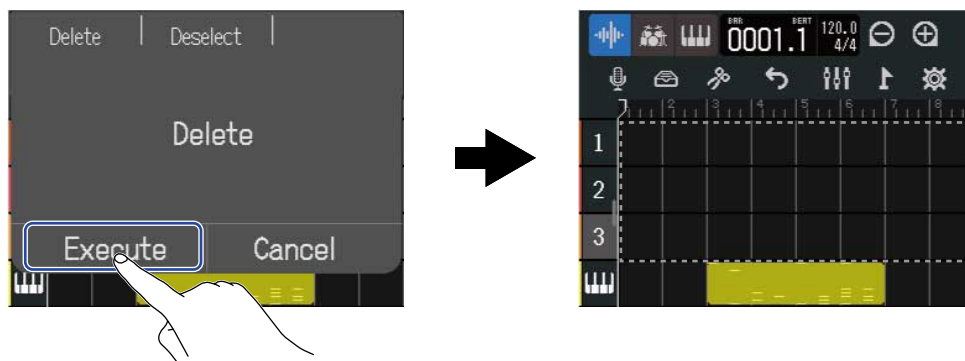

Tap "Cancel" to cancel deletion and return to the previous screen.

Splitting regions

Regions can be split.

1. On the [Track View Screen](#), move the playback position to where you want to split the region.



2. Double-tap the region that you want to split.



This highlights that region and opens the Option Menu at the top of the screen.

3. Tap "Split".

This splits the selected region at the playback position.



Editing waveforms (audio/rhythm regions)

With waveform editing, audio and rhythm regions can be stretched without changing pitch and unnecessary parts can be deleted. Use the Waveform Editing Screen to edit waveforms.

Opening the Waveform Editing Screen

1. Tap the audio or rhythm region with the waveform that you want to edit to select it. This highlights that region.





2. Tap  in the Control Bar.

The Waveform Editing Screen for the selected region opens.



■ Main operations on the Waveform Editing Screen

- Zoom out/in horizontally: Tap  / 
- Scroll horizontally: Slide left and right

HINT:

When the Waveform Editing Screen is open, pressing  will play the region.

Trimming regions

Regions can be trimmed to delete unwanted parts.

1. On the Waveform Editing Screen, drag  left/right at the bottom left and right of the region to set the range.

Set these to leave the necessary part. Parts outside the selected range will be cut.

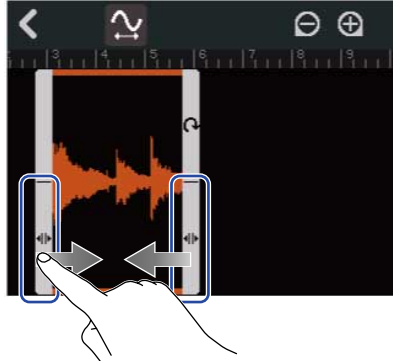

2. Tap .

This will apply the trimming and reopen the Track View Screen.



Changing region lengths without changing pitch

The lengths of regions can be changed without changing their pitches. Regions that have had lengths changed can be saved as new audio data.

1. On the Waveform Editing Screen, tap  to turn this function on () ( is off).

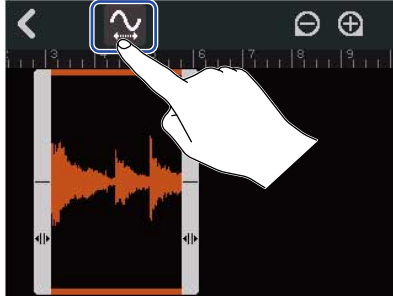

2. Drag  left and right to adjust the length of the region.

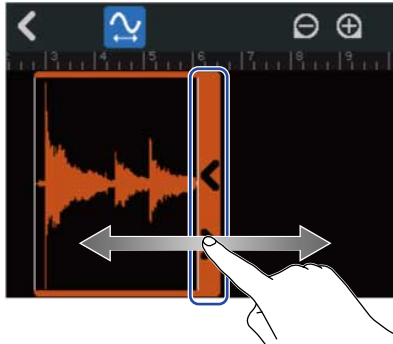

HINT:

The length can be changed in a range of 50–150% of the original file.

3. Tap “done” to confirm the setting.



4. Input the file name of the edited audio file.



See [Character Input Screen overview](#) for how to input characters.

5. When “Done” appears, tap “Close”.
The file with the changed length will be assigned to the track.

Completing editing

- 1. Tap  on the Waveform Editing Screen. The Track View Screen will reopen.





Editing notes (synth regions)

Use note editing to create MIDI data for synth playback. For example, notes can be added and deleted as well as adjusted for length and velocity. Use the Piano Role Screen for note editing.

Opening the Piano Role Screen

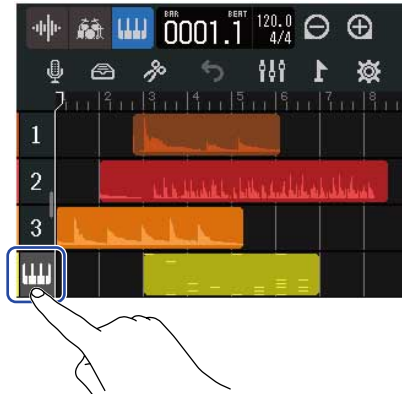
1. On the [Track View Screen](#), tap the header of the synth track with the MIDI notes you want to edit. This highlights the track header.





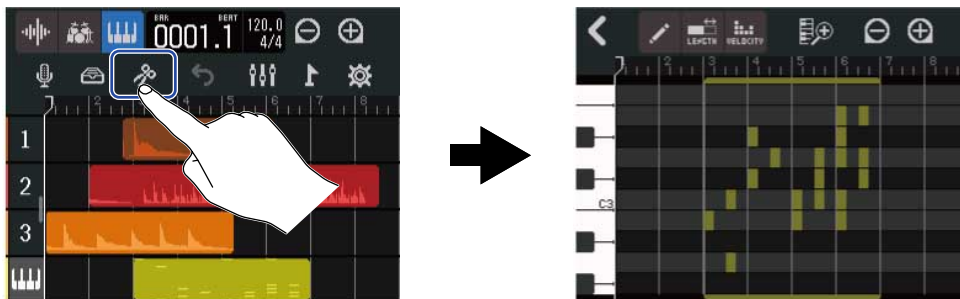

2. Tap  in the Control Bar.

The Piano Roll Screen for the selected synth track opens.





■ Main operations on the Piano Roll Screen

- Zoom in/out horizontally: Tap  / 
- Zoom in/out vertically: Tap  / 
- Scroll horizontally: Slide left and right
- Scroll vertically: Slide up and down

Adding/deleting notes

Notes can be added and used to play synth sounds using their pitch, length and velocity data.

1. On the Piano Roll Screen, tap  to turn this function on () ( is off).

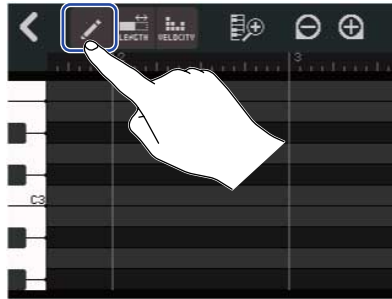

2. Add a note.

Tap the Piano Roll to add a region and note at that position.

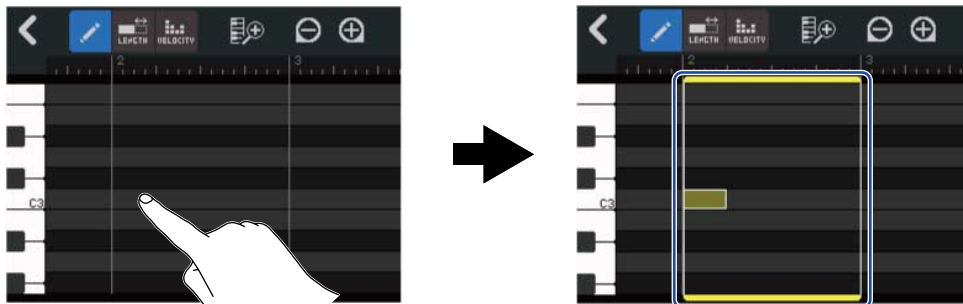

HINT:



- The pitch of the note will be the same as on the piano keyboard shown at the left edge. Scroll up/down to raise/lower the octave.
- When the place where a note will be added is tapped, vertical guidelines will be shown, allowing the position to be checked as the note is added.

3. Delete a note.

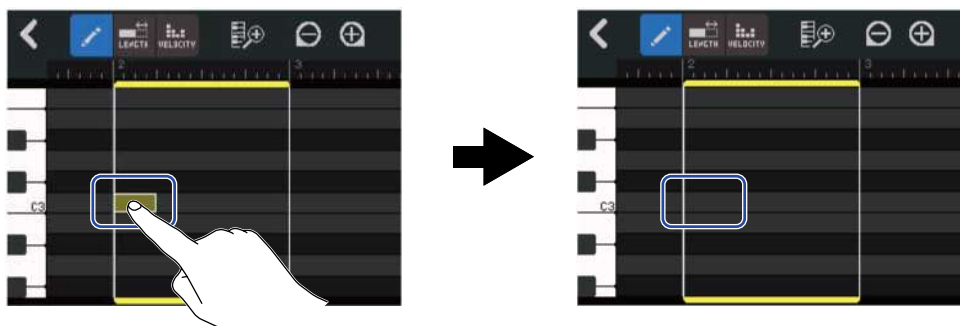
Tap a note to delete it. The remaining region will not be deleted.



Changing note lengths

1. On the Piano Roll Screen, tap  to turn this function on () ( is off).



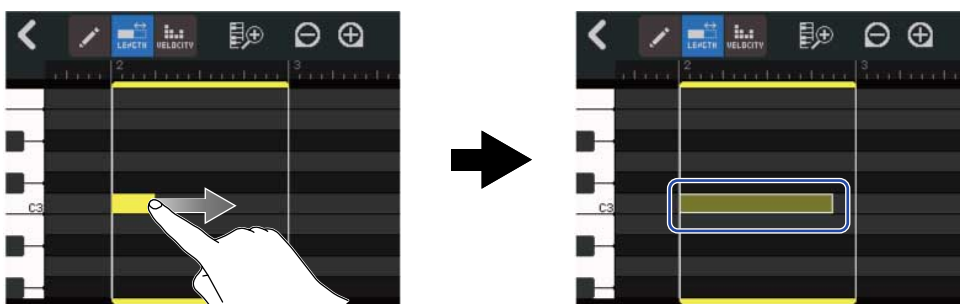

2. Tap a note and slide it left/right to change its length.



HINT:

The shortest length is a 32nd note.

Adjusting note velocity (strength)

1. On the Piano Roll Screen, tap  to turn this function on () ( is off).

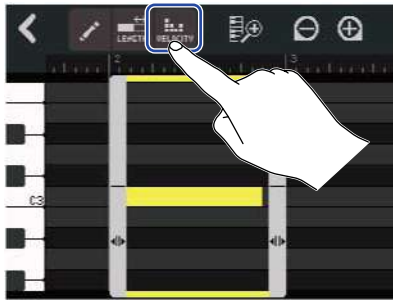

2. Tap the note for which you want to adjust the velocity.

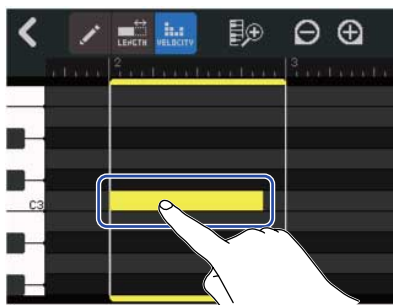

A Velocity Slider will appear at the top of the screen.

3. Slide the slider or tap  and  to adjust the velocity.

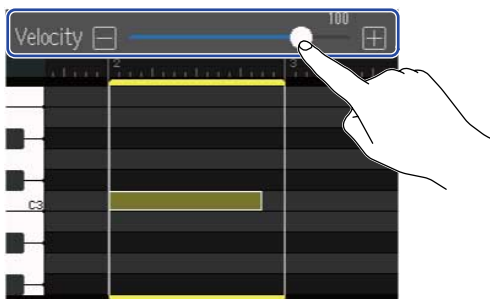



HINT:

The velocity can be set from 0 to 127.

Trimming regions

Regions can be trimmed to delete unwanted parts.

1. On the Piano Roll Screen, tap  /  /  to turn them off.

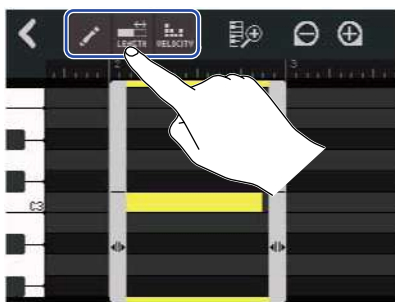

2. Drag left/right  at the bottom left/right of the region to set the range.

Set these to leave the necessary part. Parts outside the selected range will be cut.

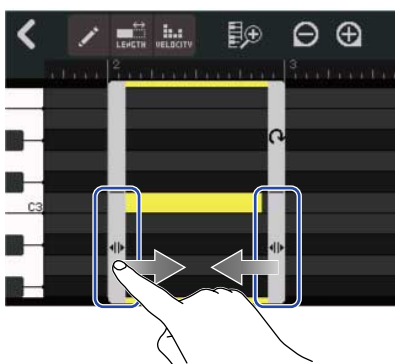

Completing editing

1. Tap  on the Piano Roll Screen.

The Track View Screen will reopen.



Editing tracks

When editing tracks, tracks can be deleted and moved, synth tracks can be converted to audio tracks, and track data can be exported as audio data.

Deleting tracks

A selected track can be deleted. All the regions in the track will also be deleted.

1. Double-tap the header of the track that you want to delete on the [Track View Screen](#).



The Option Menu will open at the top of the screen.

2. Tap "Delete".

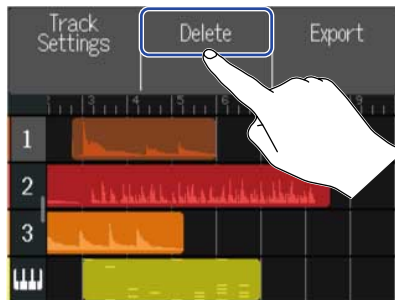

3. Tap "Execute".

This will delete the selected track and all the regions in it.

Tap "Cancel" to cancel deletion and return to the previous screen.

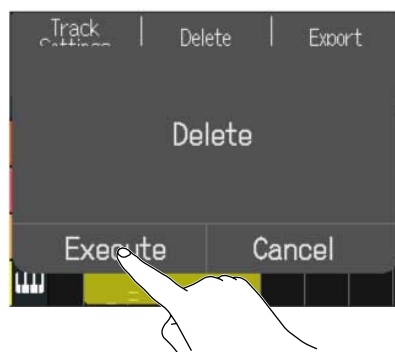

NOTE:

Be certain before using this function because deleted track files will be completely removed from the microSD card.

Converting synth tracks to audio tracks

Only one synth track is available, so converting a synth track to an audio track makes it possible to create a new synth track.

The notes of a synth track can be performed and exported as an audio file using the currently selected sound. That synth track will be converted to an audio track, and the exported audio file will be assigned to it.

1. On the [Track View Screen](#), double-tap the header of the synth track that you want to convert to an audio track.

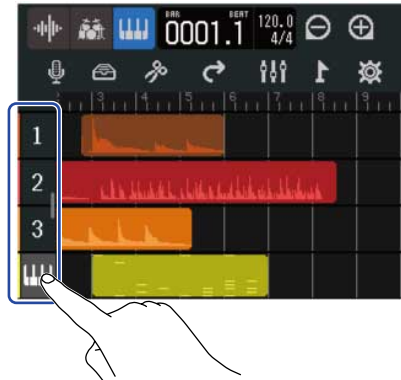

The Option Menu will open at the top of the screen.

2. Tap "Convert to Audio".

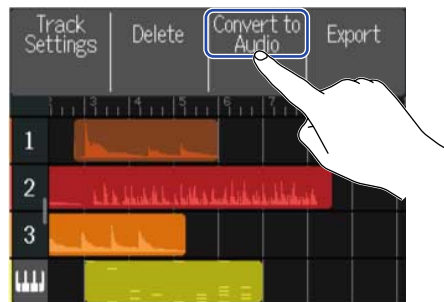

3. Slide the Length slider or tap  and .

This adjusts the rendered length.

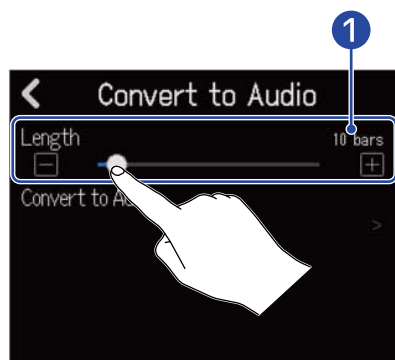

- 1 Exported length

This shows the number of bars.

4. Tap “Convert to Audio”.

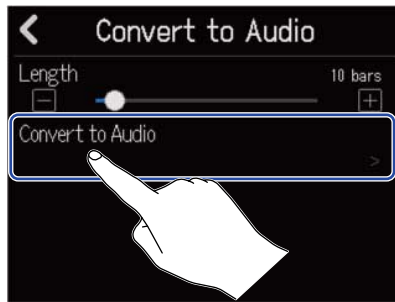

5. Input the name of the audio file to be exported.



See [Character Input Screen overview](#) for how to input characters.

6. When “Done” appears, tap “Close”.
This converts the synth track to an audio track and reopens the Track View Screen.

Exporting tracks

Tracks can be exported as WAV files to the AUDIO folder or as MIDI files to the MIDI folder on the microSD card.

1. On the [Track View Screen](#), double-tap the header of the track that you want to export as a WAV or MIDI file.



The Option Menu will open at the top of the screen.

2. Tap "Export".

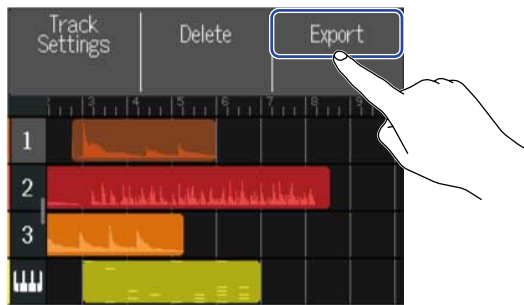

3. Slide the Length slider or tap  and .

This adjusts the rendered length.

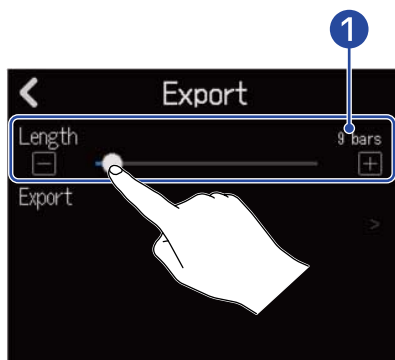

- 1 **Exported length**

This shows the number of bars.

4. Tap "Export".

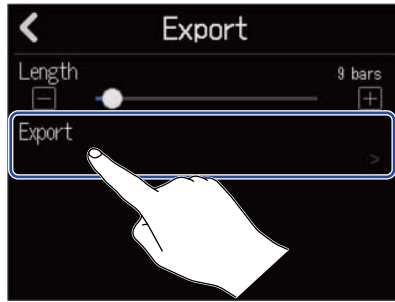

5. Input the name of the WAV or MIDI file to be exported.



See [Character Input Screen overview](#) for how to input characters.

6. When "Done" appears, tap "Close".
This exports the track as a WAV or MIDI file and reopens the Track View Screen.

Reordering tracks

1. Tap the header of the track that you want to reorder on the [Track View Screen](#). This highlights the tapped track header.



2. Drag it to the desired position.



Using markers



By adding markers with names, for example, intro, verse and chorus, to the beginnings of parts, the overall song structure can be made easy to see, which is useful when editing and mixing. Markers are shown in the Control Bar ruler.

Adding markers

1. On the [Track View Screen](#), move the playback position to where you want to add a marker.



HINT:

The playback position can be moved in ruler increments by pressing  and .

2. Tap .





This opens the Marker Menu at the top of the screen.

3. Tap "Add".

This shows information about the marker at the playback position. The marker name shown at the left end of the Marker Menu will be assigned to the marker.



HINT:

- Marker names will be assigned automatically each time a marker is added in the following order.
Intro → Verse → Chorus → Bridge → Outro → Verse → Verse → ...
Marker names can be changed in step 5.
 - By tapping   at the right end of the Marker Menu, markers can be moved one bar at a time. If another marker already exists, movement will stop at the bar next to it.
-

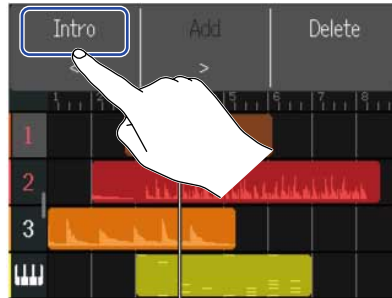
4. Tap a marker name in the Marker Menu.**5.** Change the marker name as necessary.

See [Character Input Screen overview](#) for how to input characters.

HINT:

Marker names can use a maximum of 10 characters.

6. When “Done” appears, tap “Close”.
This will add the marker and reopen the Track View Screen.**HINT:**



Up to 10 markers can be added.

Moving marker positions

1. On the [Track View Screen](#), move the playback position to the marker you want to move.



HINT:

The playback position can be moved in ruler increments by pressing  and .

2. Tap .



This opens the Marker Menu at the top of the screen.

3. Tap   to move the marker.

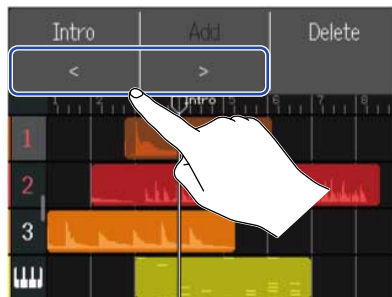

Tap anywhere else to close the Marker Menu.

HINT:



Movement is possible in bar increments. If another marker already exists, movement will stop at the bar next to it.

Changing marker names

1. On the [Track View Screen](#), move the playback position to the marker you want to rename.



HINT:

The playback position can be moved in ruler increments by pressing  and .

2. Tap .



This opens the Marker Menu at the top of the screen.

3. Tap a marker name in the Marker Menu.

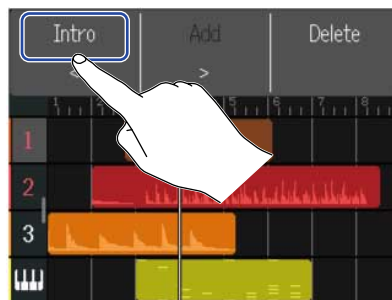

4. Change the marker name.



See [Character Input Screen overview](#) for how to input characters.

HINT:

Marker names can use a maximum of 10 characters.

5. When “Done” appears, tap “Close”.



This changes the marker name and returns to the Track View Screen.

Deleting markers

1. On the [Track View Screen](#), move the playback position to the marker you want to delete.



HINT:

The playback position can be moved in ruler increments by pressing  and .

2. Tap .

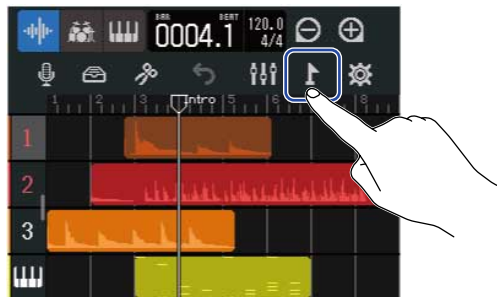

This opens the Marker Menu at the top of the screen.

3. Tap "Delete".



4. Tap "Execute".

Tap "Cancel" to cancel deletion and return to the previous screen.

5. When "Done" appears, tap "Close".
The marker will be deleted.

Mixing projects

Switch between the [Track View Screen](#) and [Level Meter View Screen](#) for different purposes when mixing.

Tap  or  to switch screens.

Switching to the Level Meter View Screen



Switching to the Track View Screen

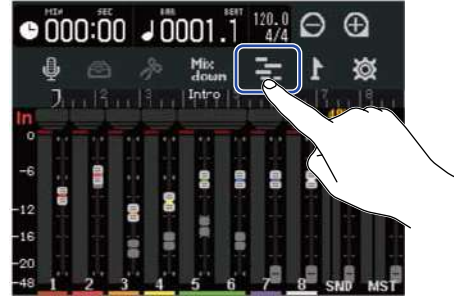

Checking track levels

The levels of all tracks, the overall level and the send effect level can be checked at a glance on the Level Meter View Screen.

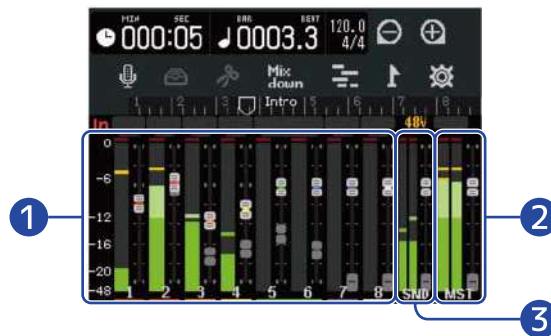



- 1 Levels and fader positions of all tracks
- 2 Overall level and MASTER fader position
- 3 Send effect level and EFFECT fader position

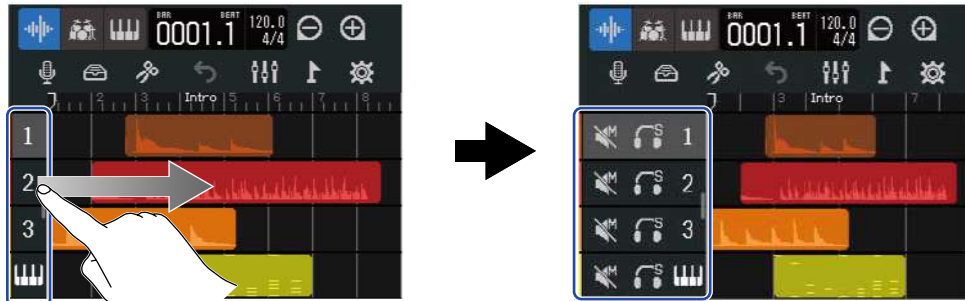

Muting tracks

The signals of specific tracks can be muted.

1. Drag the track numbers right on the [Track View Screen](#).
This opens the mixer.



2. Tap .

This mutes that track, and  lights ().



Multiple tracks can be muted at the same time.
Slide up and down on the screen to mute other tracks.

3. Drag the track numbers left to close the mixer.



Listening to selected tracks only (soloing)

Specific tracks can be selected to listen to only their signals.

1. Drag the track numbers right on the [Track View Screen](#). This opens the mixer.

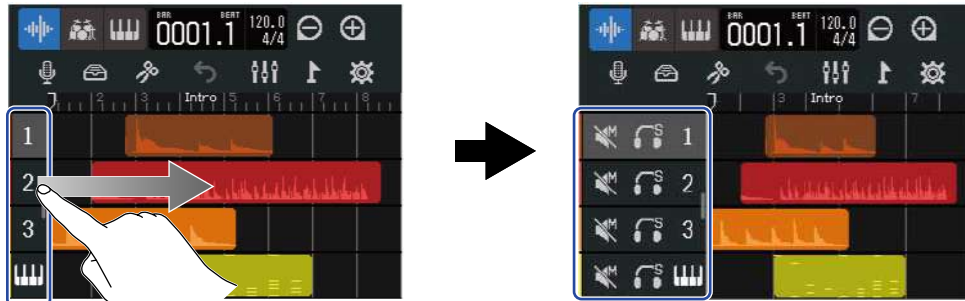

2. Tap .

This mutes all other tracks, and  lights ().



Multiple tracks can be soloed simultaneously.
Slide up and down on the screen to solo other tracks.

3. Drag the track numbers left to close the mixer.



Adjusting the volume

1. Use the channel faders to adjust the levels of individual tracks, and use the EFFECT fader for the send effect level and the MASTER fader for the overall level.

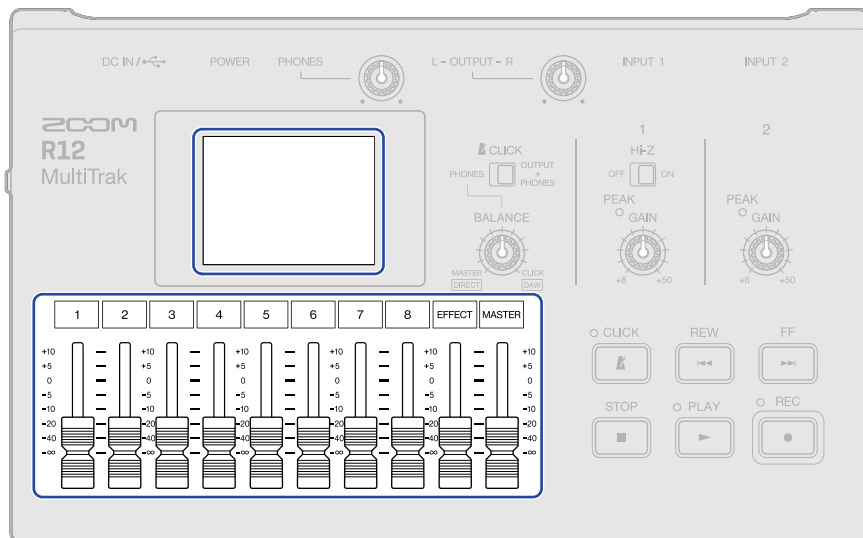

Check the levels on the [Level Meter View Screen](#).

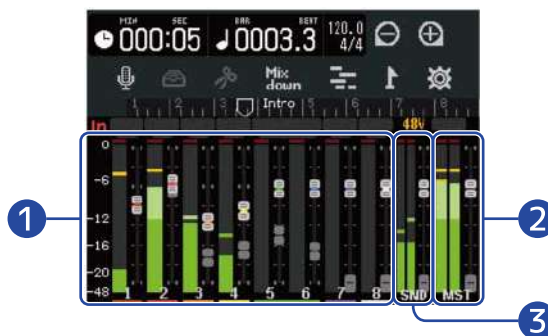

- 1 Levels and fader positions of individual tracks
- 2 Overall level and MASTER fader position
- 3 Send effect level and EFFECT fader position

HINT:

If the position of a physical fader and its fader setting are different, the physical fader will not adjust the level. First, align the physical fader position with the current fader position. Then, the position of the physical fader will start adjusting the level.

**1 Track faders**

These show the current fader position settings.

2 Track ghost faders

When the positions of physical faders and fader settings are different, these show the physical fader positions.

Adjusting the panning, EQ and effects of tracks

Adjusting panning

The left-right stereo panning of track playback sounds can be adjusted.

See [Adjusting panning for monitoring](#) for operation details.

Adjusting EQ

The frequency bands of individual tracks can be boost/cut.

See [Adjusting EQ](#) for details about operation.

Using effects

Effects can be applied to each track.

See [Using effects](#) for details about operation.

Mixing down

A recorded project can be mixed and output as a stereo mixdown file (WAV).

The mixed-down stereo file will be saved in the "AUDIO" folder on the microSD card with the following format.

- Sample rate: 44.1 kHz
- Bit depth: As set during project creation (→ [Creating empty projects using specific settings](#))

1. Tap **Mix down** on the [Level Meter View Screen](#).

Mix down will light (**Mix down**).

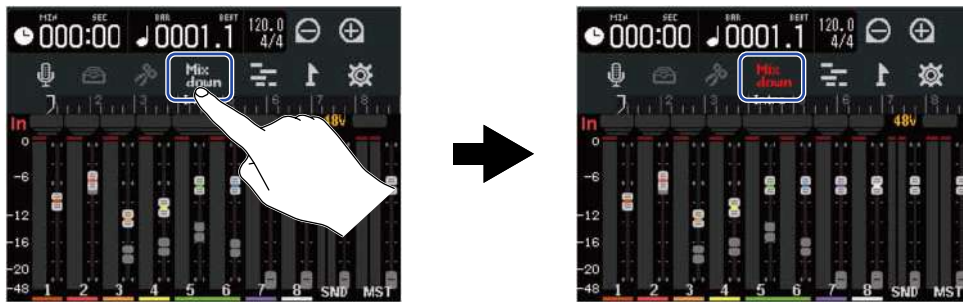

2. Press .

This starts mixdown from the beginning of the project.

Level adjustments made with the channel, MASTER and EFFECT faders during mixdown will affect the mixdown recording.

3. Press  to stop the mixdown.

Managing projects

Projects created on the R12 are saved on the microSD card.

The names of projects saved on microSD cards can be changed. These projects can also be copied and deleted and their creation date/time and format data can be checked.

When a USB flash drive is connected to the R12, projects can be saved on it and loaded from it. Audio data and MIDI files can also be loaded from it.

Conduct these operations from the Project Option Screen.

Folder and file structure on microSD cards

When recording with the R12, folders and files are created on microSD cards in the following manner.

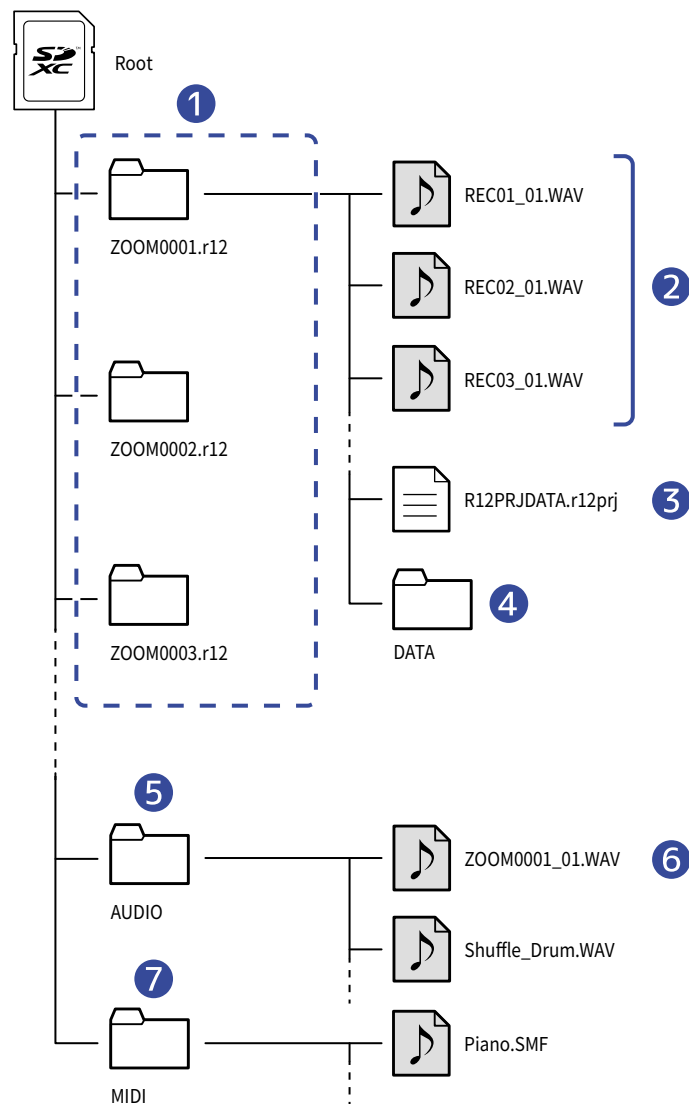

1 Project folders

These contain project recording data and settings.

Folders are created with the names "ZOOM0001" – "ZOOM9999".

2 Audio files recorded for each track

Audio files will be created with names as follows.

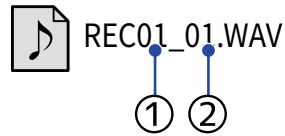

① Track number

② Recording number ("01" is the first recording, followed by "02", "03" and so on.)

Example: The name of the file for the second recording made on track 4 would be "REC04_02.WAV".

3 Project file

Project specific settings are saved in this file.

4 DATA folder

Data necessary for the project structure are saved in this folder.

5 AUDIO folder

This stores WAV files to be added to projects. Put WAV files that you want to load in the R12 here. In addition, mixdown audio files and WAV files exported following the instructions in [Rendering projects as WAV files](#) are stored here.

6 Mixdown audio file

The number after the project name in the file name shows the mixdown number.

7 MIDI folder

This stores MIDI files to be added to projects. Put MIDI files that you want to load in the R12 here.

Folder and file structure on USB flash drives

When a USB flash drive is connected to the R12, folders are created as shown below.

The R12 can write project data to the following folders and load necessary files from them.

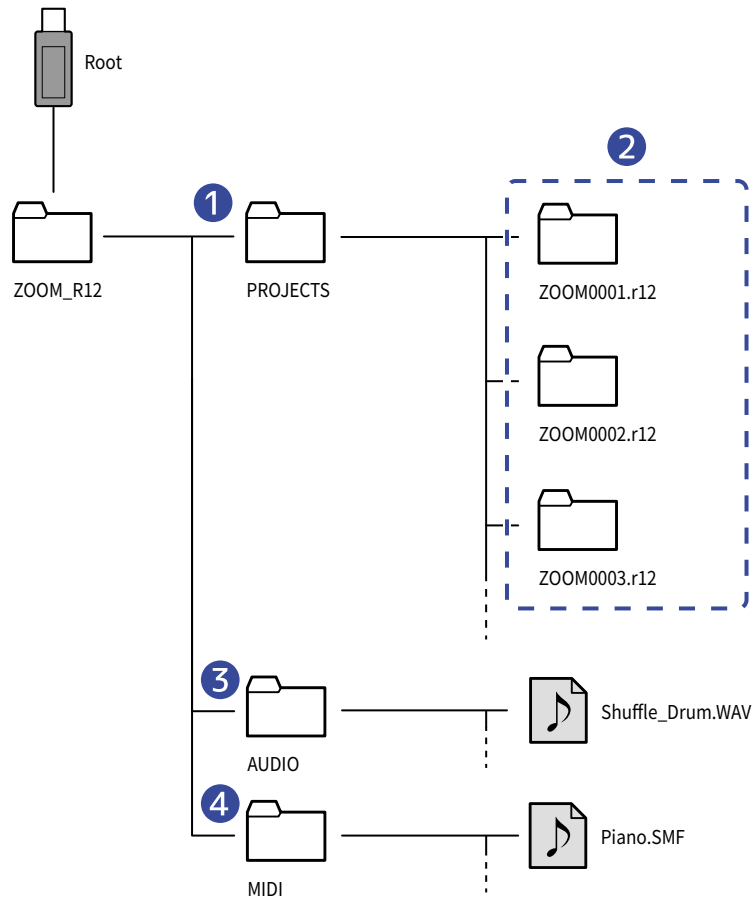

1 Folder for saving projects

This stores projects saved on the USB flash drive. Save projects that you want to load in the R12 here.

2 Project folders

These contain project recording data and settings.

3 AUDIO folder

This stores WAV files to be added to projects. In addition, WAV files exported following the instructions in [Rendering projects as WAV files](#) are stored here. Put WAV files that you want to load in the R12 here.

4 MIDI folder

This stores MIDI files to be added to projects. Put MIDI files that you want to load in the R12 here.

Connecting USB flash drives

Connect USB flash drives to the USB port.

Use USB flash drives that are compatible with USB Type-C.

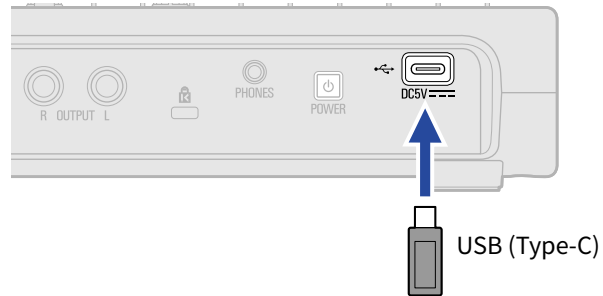

NOTE:

- Never disconnect a USB flash drive when data is being transferred.
- To connect a USB flash drive while an AC adapter is connected, use a USB Hub that supports the Power Delivery function.

Opening the Project Option Menu

Manage projects on the Project Option Screen.

1. Tap  on the Home Screen (Track View Screen/Level Meter View Screen).

Track View Screen



Level Meter View Screen



This opens the Project Settings Screen.

2. Tap "Projects" on the Project Settings Screen.

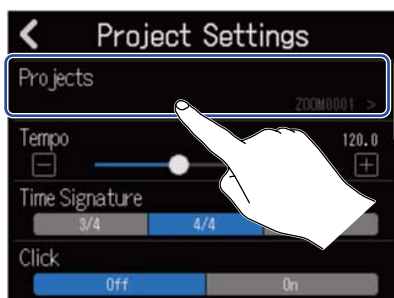

This opens the Projects Screen.

3. Tap the project you want to manage.



The selected project will be framed in blue.

4. Tap "Option".

This opens the Project Option Screen for the selected project.

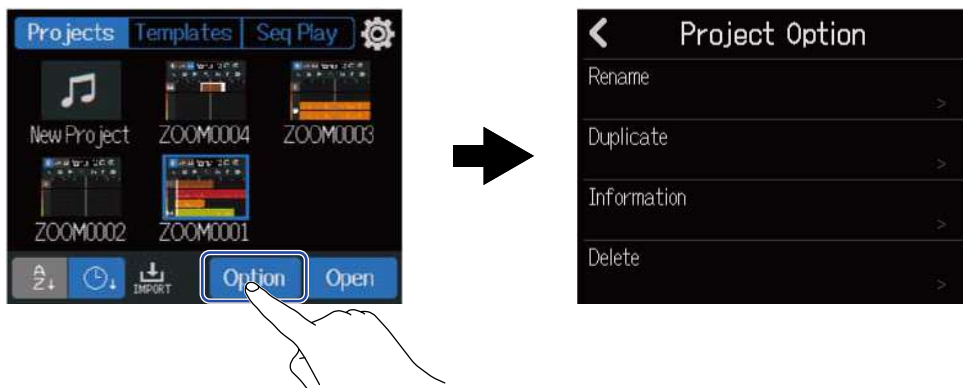

Changing project names

1. Tap “Rename” in the Project Option Menu (→ [Opening the Project Option Menu](#)) of the project that you want to rename.

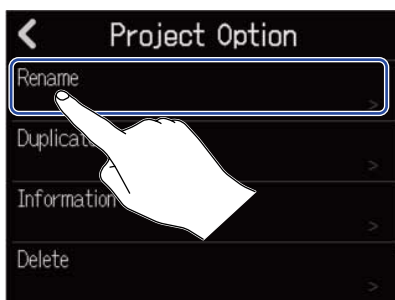

2. Change the project name.



See [Character Input Screen overview](#) for how to input characters.

NOTE:

- An error message will appear if the same name already exists after changing a project name. If this happens, change the project name.
- Usable project names can have a maximum of 50 characters, including their extensions.

3. When “Done” appears, tap “Close”.

Duplicating projects

1. Tap “Duplicate” in the Project Option Menu (→ [Opening the Project Option Menu](#)) of the project that you want to duplicate.

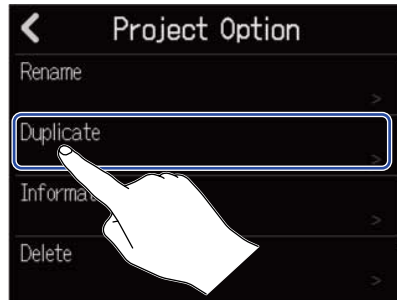

2. Input the name for the duplicated project.



See [Character Input Screen overview](#) for how to input characters.

NOTE:

- An error message will appear if the same name already exists after changing a project name. If this happens, change the project name.
- Duplication is not possible if a microSD card does not have enough open space.
- Duplication is not possible if 1000 projects already exist.

3. When “Done” appears, tap “Close”.
This completes duplication and reopens the original screen.

Checking project information

1. Tap “Information” in the Project Option Menu (→ [Opening the Project Option Menu](#)) of the project with information that you want to check.

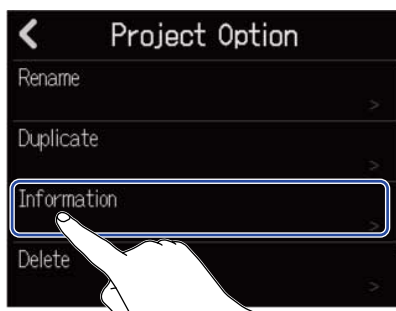

This opens the project Information Screen where you can check the following information.

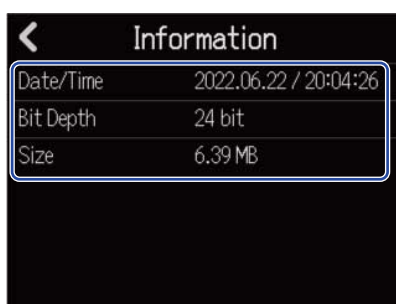

Item	Explanation
Date/Time	Date and time of project creation
Bit Depth	Recording format
Size	Project size

Deleting projects

1. Tap "Delete" in the Project Option Menu (→ [Opening the Project Option Menu](#)) of the project that you want to delete.

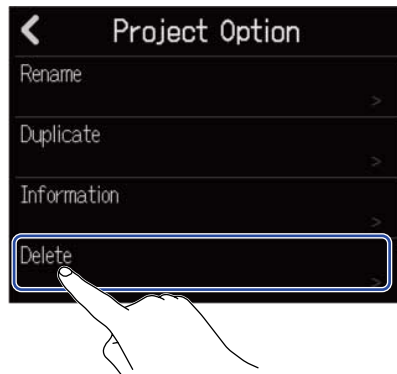

2. Tap "Execute".

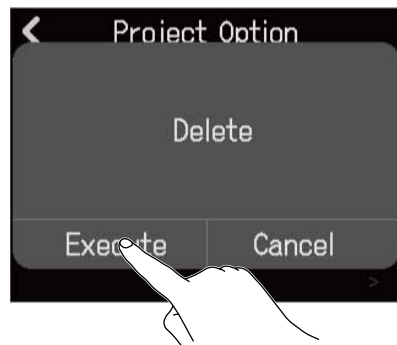

Tap "Cancel" to cancel deletion and return to the previous screen.

3. When "Done" appears, tap "Close".
This deletes the selected project and reopens the Projects Screen.

Rendering projects as WAV files

Projects can be rendered in the following format to the AUDIO folder on a microSD card or the ZOOM_R12 > AUDIO folder on a USB flash drive.



- Stereo WAV file
- Sample rate: 44.1 kHz
- Bit depth: As set during project creation (→ [Creating empty projects using specific settings](#))

NOTE:

To render to a USB flash drive, connect it to the USB (Type-C) port. (→ [Connecting USB flash drives](#))

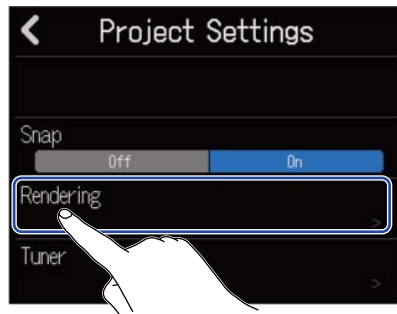
1. Tap “Rendering” on the Project Settings Screen (→ [Opening the screen where various project settings can be made](#)).



2. Slide the Length slider or tap  and  .
This adjusts the rendered length.

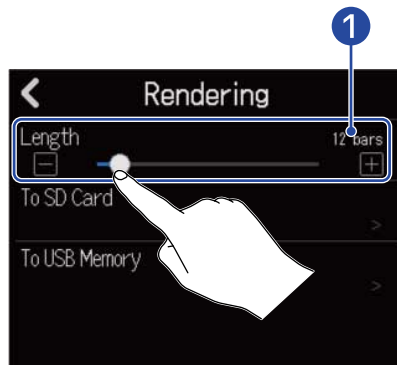

1 Rendered length

This shows the number of bars.

3. Tap where the rendered stereo WAV file should be saved.

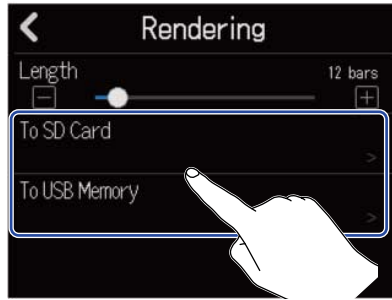

Setting	Explanation
To SD Card	This renders to the microSD card.
To USB Memory	This renders to the USB flash drive.

4. Input the file name.



See [Character Input Screen overview](#) for how to input characters.

NOTE:

- An error message will appear if a file with the same name already exists. If this happens, change the file name.
- Exporting is not possible if the microSD card or USB flash drive does not have enough open space.

5. When “Done” appears, tap “Close”.

This completes rendering of the WAV file and reopens the Project Option Screen.

Saving projects to USB flash drives

Projects are saved to microSD cards, but backups can also be saved to USB flash drives. Projects will be saved in the ZOOM_R12 > PROJECT folder on a USB flash drive.

1. Connect a USB flash drive to the USB (Type-C) port (→ [Connecting USB flash drives](#)).
2. Tap “Export To USB Memory” in the Project Option Menu (→ [Opening the Project Option Menu](#)) of the project that you want to save.



This opens the Project Name Input Screen.

3. Input the project name.



See [Character Input Screen overview](#) for how to input characters.

NOTE:

- An error message will appear if a project with the same name already exists. If this happens, change the project name.
- Saving is not possible if a USB flash drive does not have enough open space.
- Usable project names can have a maximum of 50 characters, including their extensions.

4. When “Done” appears, tap “Close”.
This completes saving and reopens the Project Option Screen.

Importing projects from USB flash drives

Projects saved in the ZOOM_R12 > PROJECTS folder on a USB flash drive can be imported to microSD cards. (→ [Folder and file structure on USB flash drives](#))

1. Connect a USB flash drive to the USB (Type-C) port (→ [Connecting USB flash drives](#)).

2. Tap  on the Projects Screen (→ [Opening projects](#)).



3. Tap the project that you want to import.

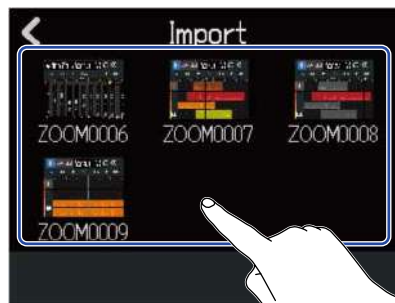

4. Input the project name.



See [Character Input Screen overview](#) for how to input characters.

NOTE:

- An error message will appear if a project with the same name already exists. If this happens, change the project name.
- Importing is not possible if a microSD card does not have enough open space.

5. When “Done” appears, tap “Close”.

This completes importing and reopens the Import Screen (shown in step 3).

Using as an audio interface

The R12 can be used as a 2-in/4-out or 2-in/2-out audio interface.

The R12 can send 2 separate channels of track audio signals or a mixed stereo signal to a computer, smartphone or tablet.

Either 2 or 4 channels of audio signals can be input from a computer, smartphone or tablet.

Installing drivers

Windows computers

1. [Download the R12 Driver to the computer from zoomcorp.com.](http://zoomcorp.com)

NOTE:

The latest R12 Driver can be downloaded from the above website.

2. Launch the installer and follow its instructions to install the R12 Driver.

NOTE:

See the Installation Guide included in the driver package for detailed installation procedures.

Smartphones, tablets and Mac computers

No drivers are necessary for use with smartphones, tablets and Mac computers.

Connecting computers, smartphones and tablets

1. Tap  on the Projects Screen (→ [Opening projects](#)).



2. Tap "Audio Interface".

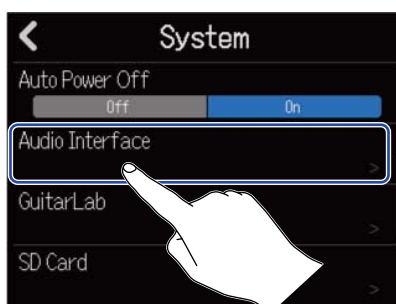

3. Tap a mode to select it.



Setting	Explanation
2In/2Out	This mode sends a stereo signal that is a mix of all tracks.
2In/2Out (iPad)	Use this to connect a smartphone/tablet with a 2-in/2-out setting Use AA batteries to operate the R12.
2In/4Out	This 2-in/4-out connection mode sends the signals of each track separately to a computer.

The Level Meter View Screen for the selected mode will open.

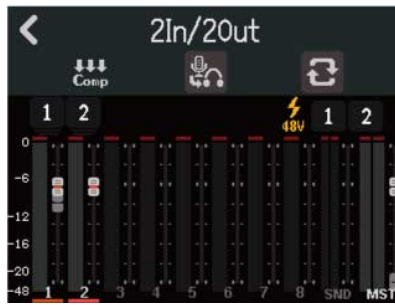

4. Use a USB cable to connect the R12 with a computer, smartphone or tablet.

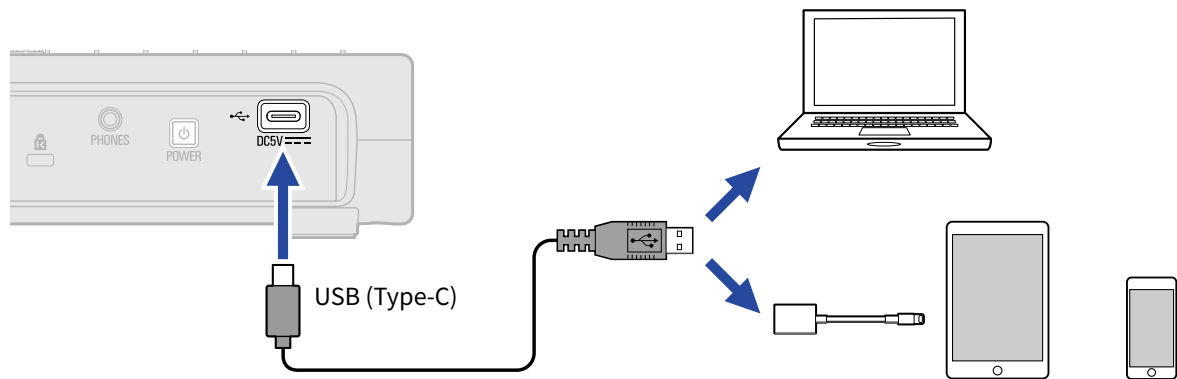

NOTE:

- Use a USB (Type-C) cable that supports data transfer.
- When connecting to a computer, set the R12 as the sound device.
- Use a Lightning to USB 3 Camera Adapter to connect to an iOS/iPadOS device with a lightning connector.

HINT:

- To make sound monitoring, output level and other settings, see [Making audio interface settings](#).
- When in 2In/4Out mode, the stereo signal mixed by the R12 is transmitted. See [Mixing projects](#) for details about mixing.

Disconnecting computers, smartphones and tablets

1. Tap  on the audio interface Level Meter View Screen.

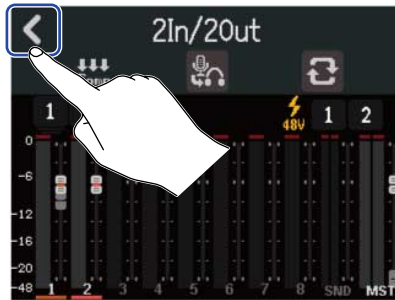

2. Tap "Execute".



This disables the audio interface function and opens the Settings Screen.
Tap "Cancel" to return to the previous screen.

3. Disconnect the USB cable connecting the R12 and the computer, smartphone or tablet.

Making audio interface settings

Settings can be made for the monitoring sound and the Comp/Limiter/Gate function used on sounds input to the R12.



Setting direct monitoring

This function directly outputs the sound being recorded by the R12 before sending it to the computer, smartphone or tablet. This enables monitoring without latency (direct monitoring).

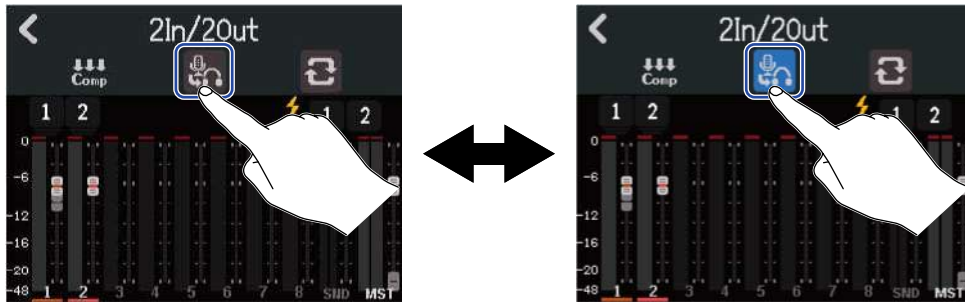

1. Tap  on the audio interface Level Meter View Screen.

Tapping this switches the setting.



Setting	Explanation
	This turns off direct monitoring. This outputs the sound being recorded by the R12 after sending it to the computer, smartphone or tablet.
	This turns on direct monitoring.

NOTE:

- When in 2In/4Out mode (→ [Connecting computers, smartphones and tablets](#)), the direct monitoring sound is from the pre-fader mix, so fader adjustments will not affect the volume.
- When in 2In/2Out mode (→ [Connecting computers, smartphones and tablets](#)), the direct monitoring sound is from the post-fader mix, so fader adjustments will affect the volume.
- In 2In/2Out mode, (→ [Connecting computers, smartphones and tablets](#)),  can be used to balance the levels of the sound captured by the R12 (direct monitoring sound) and the sound that passes through the computer, smartphone or tablet (from a DAW, for example). Regardless of the  setting, the sound output from the PHONES jack can be adjusted.

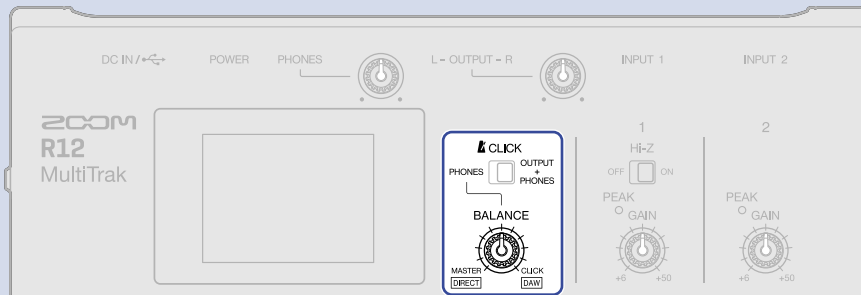

Enabling the loopback function (2In/2Out mode only)



This function allows the playback sound from the computer, smartphone or tablet and the R12 inputs to be mixed and sent back (looped back) to the computer, smartphone or tablet.

This function can be used, for example, to add narration to music played back from a computer and record the mix or stream it on the computer.

1. Tap  on the audio interface Level Meter View Screen.

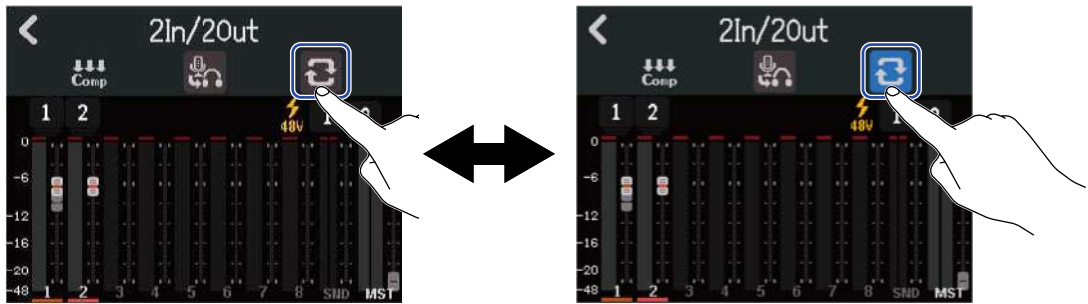
Tapping this switches the setting.



Setting	Explanation
	This turns off the Loopback function.
	This turns on the Loopback function.

Setting the Comp/Limiter/Gate function

Settings can be made for the Comp/Limiter/Gate function used on sounds input to the R12.

1. Tap  on the audio interface Level Meter View Screen.

This opens a screen to set the Comp/Limiter/Gate function.

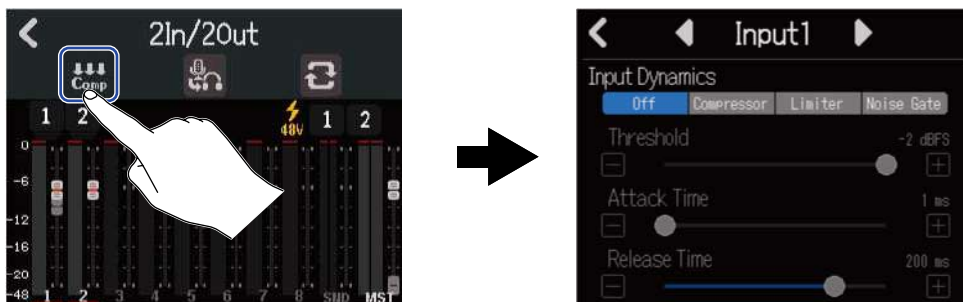

See [Using the Comp/Limiter/Gate function](#) for details about making settings.

Using as a control surface

When the R12 is connected by USB and used as an audio interface, its keys and faders can be used to control DAW transport and mixing operations.



Enabling control surface use

1. Connect to a computer as an audio interface in 2In/4Out mode (→[Connecting computers, smartphones and tablets](#))

2. Tap .

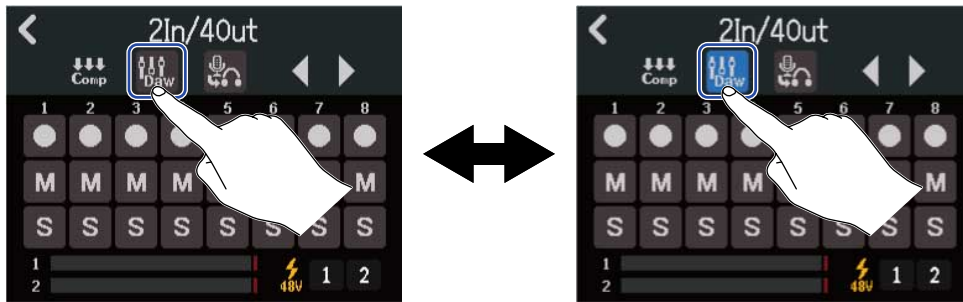
Tapping this switches the setting.



Setting	Explanation
	This turns off the control surface function.
	This turns on the control surface function.

Making DAW settings





The R12 control surface function conforms to the Mackie Control standard.

In the DAW settings menu, add "Mackie Control" to the "Devices", and select "ZOOM R12" for MIDI input and output. For details, see the manual of the DAW being used.

R12 functions

The buttons and faders as well as on-screen buttons on the R12 can be operated to control various DAW functions.

Button and fader functions

Button/fader	Explanation
Channel faders	Adjust volumes of corresponding tracks
Master fader	Adjust master volume
	Search backward
	Search forward
	Stop
	Start playback
	Record

Screen button functions

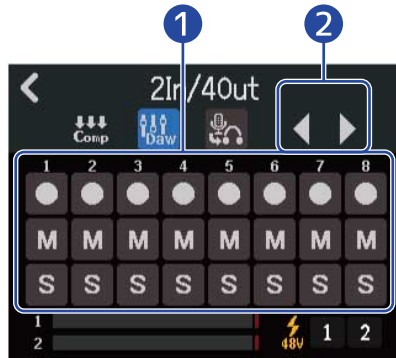

- 1 Rec/Mute/Solo buttons**
Use to set the track REC button function.
- 2 Track Bank buttons**
Use to switch the bank.

Playing back projects in order (sequential play)

Multiple projects can be added to a playlist and played back in order.

This is convenient for live performances and output to an external recorder, for example.

Creating playlists

1. Tap "Seq Play" on the Projects Screen (→ [Opening projects](#)).



This opens the Seq Play Screen.

2. Tap "New List" to select it.

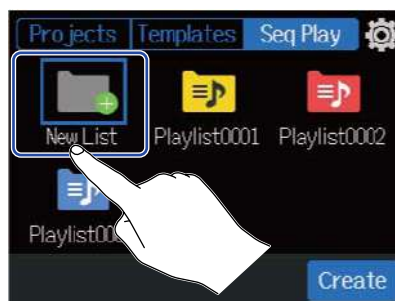

3. Tap "Create".

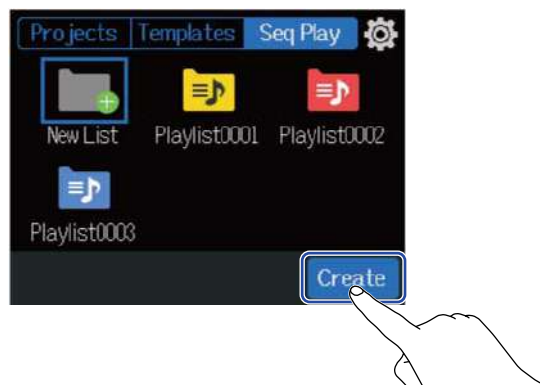

4. Input the playlist name.



See [Character Input Screen overview](#) for how to input characters.

5. When "Done" appears, tap "Close".
The Playlist Editing Screen opens.

6. Tap "Add Project".



7. Tap the project you want to add to the playlist, and tap "Add".
The selected project will be added to the playlist.

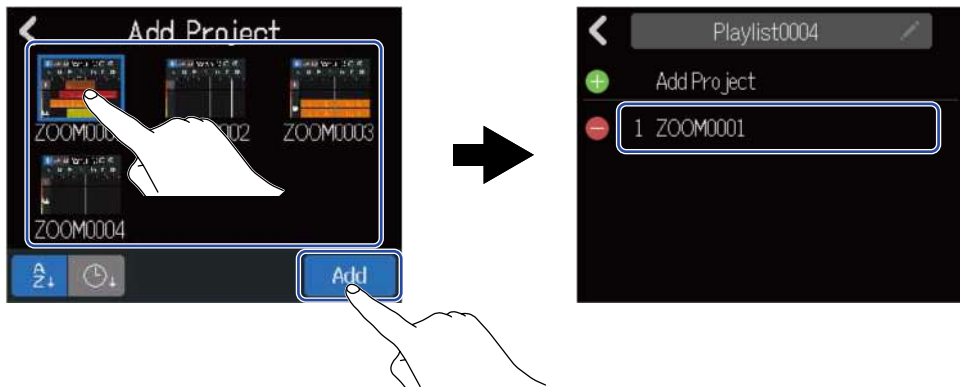

8. Repeat step 7 to create the playlist. When finished, tap  .
The new playlist will be added to the Seq Play Screen.

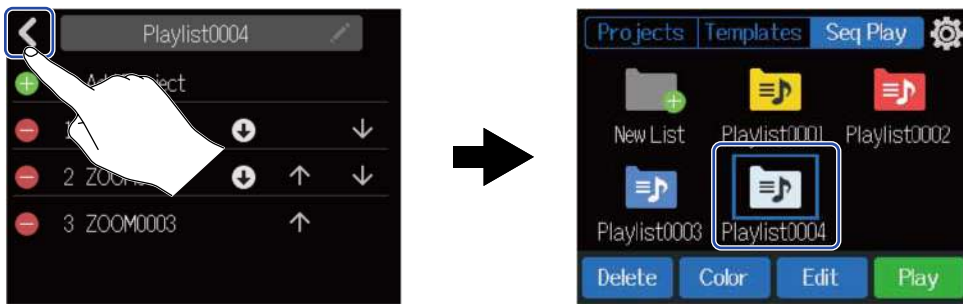

Editing playlists

Projects can be added to and removed from playlists. Playback order can also be changed, and projects can be set to pause after they are played.

1. Tap the playlist that you want to edit on the Seq Play Screen ([Creating playlists](#)).

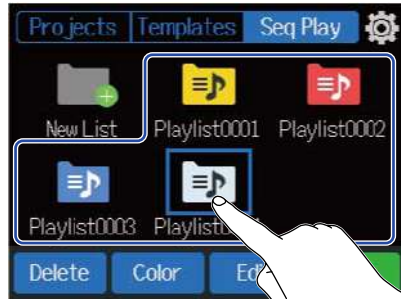

2. Tap "Edit".
The Playlist Editing Screen for the selected playlist opens.

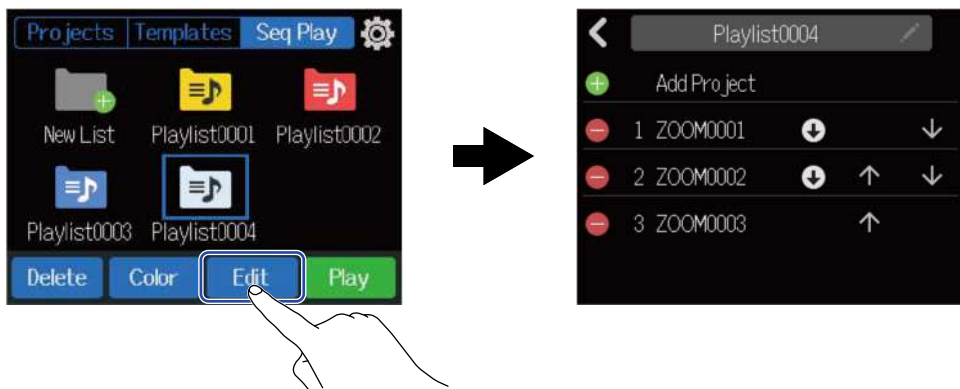

3. Edit the playlist.

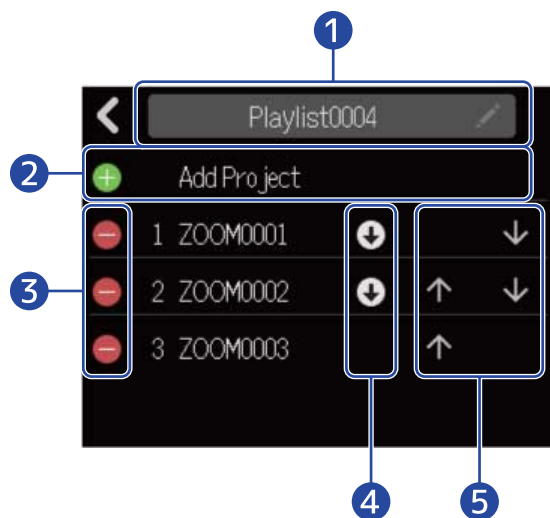

- 1 **Playlist name**
Tap the playlist name to change it.
See [Character Input Screen overview](#) for how to input characters.

2 Add project

Tap this to open a screen where projects can be added to the playlist. See [Creating playlists](#) for the procedure to add projects.

3 Delete project



Tap these to delete projects from the playlist.

Tap "Execute" to confirm deletion.



Tap "Cancel" to cancel deletion.

4 Pause setting

Playlist playback can be set to pause after specific projects complete playing. Tap this icon to switch the setting.

-  Continue playing the next project.
-  Pause playback after this project completes playing.

5 Change playback order

-  Tap this to move one position forward in order.
-  Tap this to move one position backward in order.

Deleting playlists

1. Tap the playlist that you want to delete on the Seq Play Screen ([Creating playlists](#)).



2. Tap "Delete".



3. Tap "Execute".
The selected playlist will be deleted.

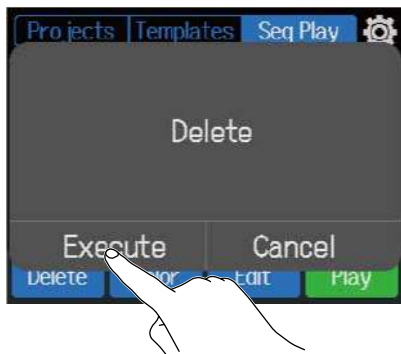

Tap "Cancel" to cancel deletion and return to the previous screen.

Changing playlist icon colors

The colors of playlist icons shown on the Seq Play Screen can be changed.

1. Tap the playlist with the icon color that you want to change on the Seq Play Screen ([Creating playlists](#)).

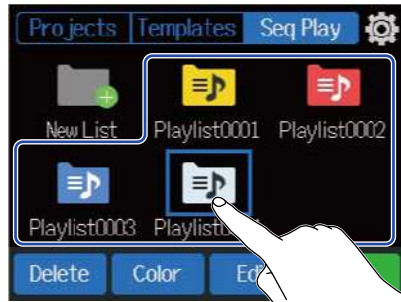

2. Tap "Color".



3. Touch the color that you want to use.
The icon will change to the selected color.

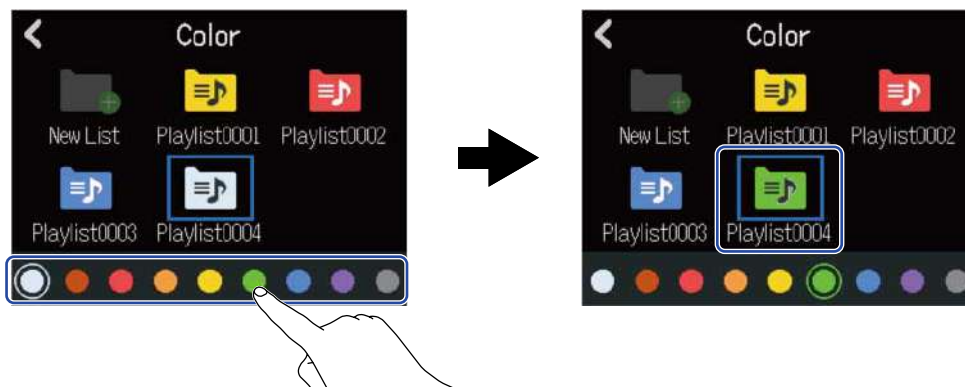

Playing playlists

1. Tap the playlist that you want to play on the Seq Play Screen ([Creating playlists](#)).

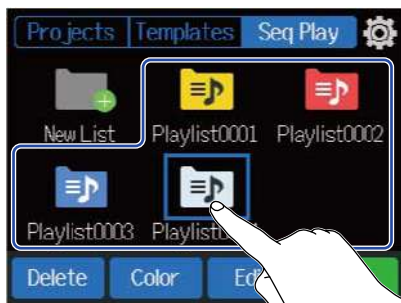

2. Tap "Play".
This opens the Sequence Playback Screen.





The projects that have been added to the playlist will be shown in a list and played in the order on the screen.

NOTE:

"End of List" will appear after the last project in the playlist.









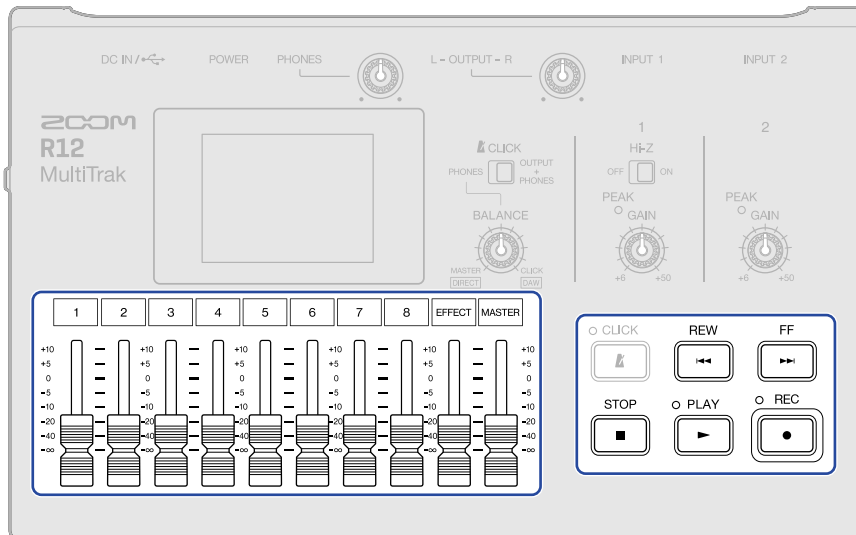

3. Press .

HINT:

Use  /  to select the previous/next project.

Button operations during playback



- Stop: Press  or .
- Search backward/forward: Press and hold  / .
- Play previous/next project: Press  / .
- Return to beginning: Press  when stopped
- Adjust track volume: Move channel fader
- Adjust master track volume: Move MASTER fader
- Adjust send effect volume: Move EFFECT fader
- Move to previous/next marker: Press  +  /  + .

Screen during playback

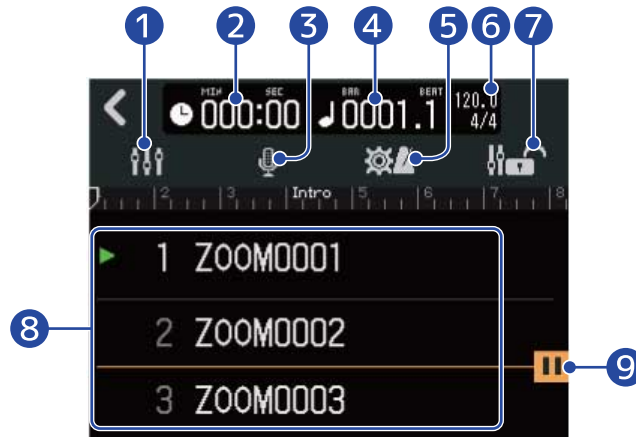

1 Screen switching button

This opens the Level Meter View Screen.

See [Level Meter View Screen](#) for an explanation of this screen.

2 Playback time

This shows the playback position of the playing project in minutes and seconds.

3 Input selection button

This opens the Input Routing Screen where INPUT 1–2 jack input, phantom power on/off, and compressor/limiter/gate settings can be made. (→ [Enabling tracks for recording](#))

4 Playback bars and beats

This shows the playback position of the playing project in bars and beats.

5 Project Settings button

This opens the Projects Settings Screen where the following settings can be made.

- Output destination of each track (→ [Setting tracks for output as MASTER and CLICK signals.](#))
- Click sound (→ [Changing the click sound](#))
- Click volume(→ [Setting the click volume](#))

6 Tempo and time signature

This shows the tempo and time signature of the playing project.

7 Fader lock icon

This can be tapped, lighting it (), to lock the faders.

This can prevent fader misoperation.

8 Project list

This shows 3 projects that have been added to the playlist, starting with the project that is currently playing.

 lights next to the project that is now playing or paused.

9 Pause setting icon

This is shown after a project that has the pause function enabled (→ [Editing playlists](#)).

Playback will automatically pause at this point.

Using Guitar Lab

The Guitar Lab application can be used on a computer (Mac/Windows) to add effects that are distributed online as well as to edit and back up patch memories, for example.

HINT:

- Download Guitar Lab from the ZOOM website. (zoomcorp.com)<https://zoomcorp.com>
- See the app manual for setting and operation procedures.

Connecting to a computer

1. Tap  on the Projects Screen (→ [Opening projects](#)).



2. Tap "Guitar Lab".
This opens the Guitar Lab Screen.

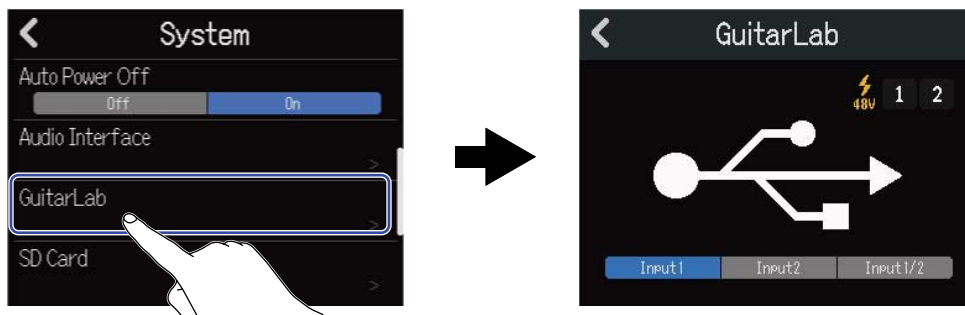

3. Use a USB (Type-C) cable to connect the R12 and the computer.

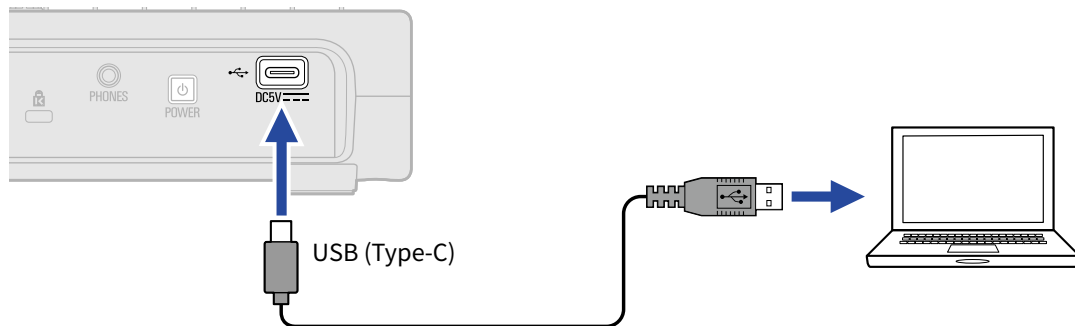

NOTE:

- Use a USB (Type-C) cable that supports data transfer.
- The R12 can be operated using USB bus power.

4. Launch Guitar Lab on the computer.

5. Tap an input to select it for effect use.

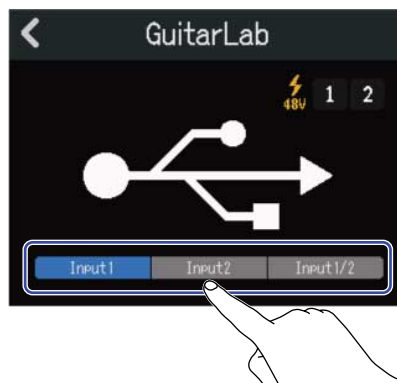

Disconnecting from the computer

1. Tap  on the Guitar Lab Screen.

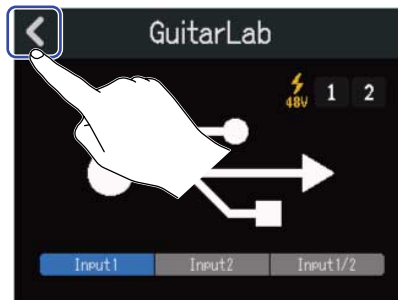

2. Tap "Execute".

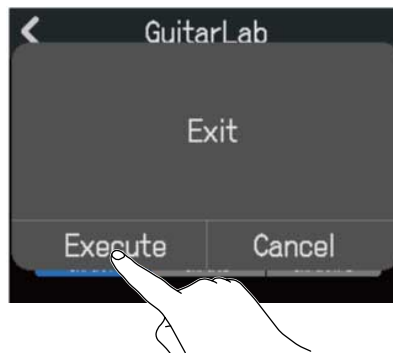

Tap "Cancel" to return to the previous screen.

3. Disconnect the USB cable connecting the R12 and the computer.

Using MIDI keyboards

The R12 has a variety of synth sounds. By connecting a MIDI keyboard (sold separately) to the R12, performances using it to play desired sounds can be recorded.

Connecting MIDI keyboards

1. Use a USB (Type-C) cable to connect the R12 and the MIDI keyboard.
See the manual included with the MIDI keyboard for details about its settings.

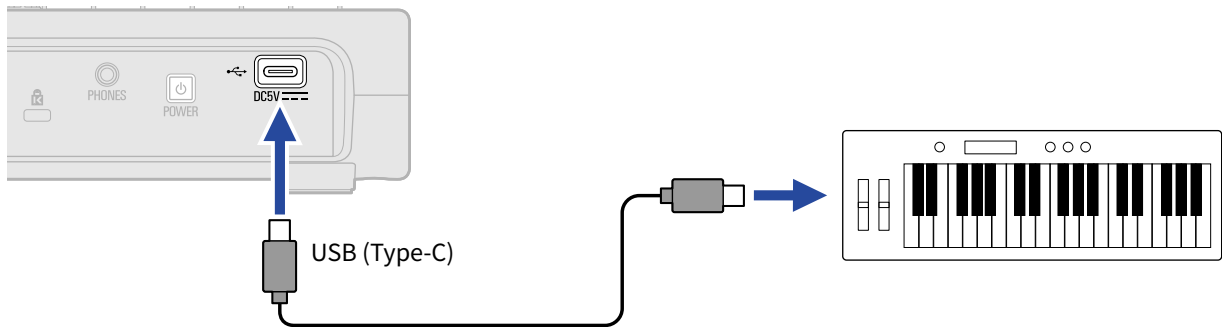

NOTE:

- The USB (Type-C) port supplies 5 V/500 mA power.
- Synth sounds can be played with the MIDI keyboard at the following times.
 - When the Synth Sound Selection/Confirmation Screen is open (→ [Selecting the synth sound](#))
 - When the synth track is enabled for recording (→ [Enabling tracks for recording](#))

Disconnecting MIDI keyboards

1. Disconnect the USB cable connecting the R12 and the MIDI keyboard.

Setting the Auto Power Off function

The power will automatically turn off if the R12 is unused for 10 hours.

To keep the power on at all times, turn off the automatic power saving function.

1. Tap  on the Projects Screen (→ [Opening projects](#)).



2. Tap "On" or "Off" for "Auto Power Off".

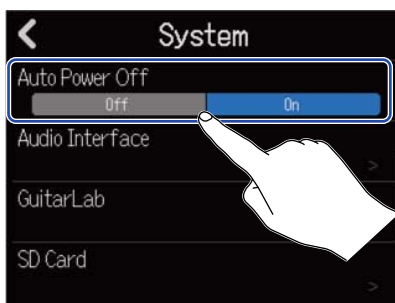

Setting	Explanation
Off	The power will not turn off automatically.
On	The power will automatically turn off if it is unused for 10 hours.

NOTE:

Under the following conditions, the power will not turn off automatically even if set to "On".

- During playback or recording
- When using the R12 as an audio interface
- When using the R12 as a card reader

Setting the date and time



Set the date and time added to recording files.

1. Tap  on the Projects Screen (→ [Opening projects](#)).

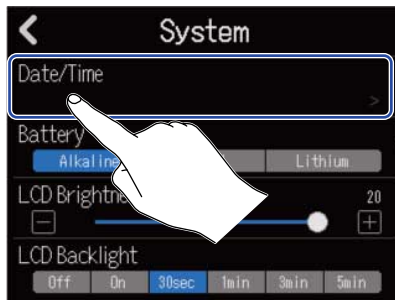

2. Tap "Date/Time".



3. Tap  /  to set the date and time.



4. Tap the displayed date format to use.

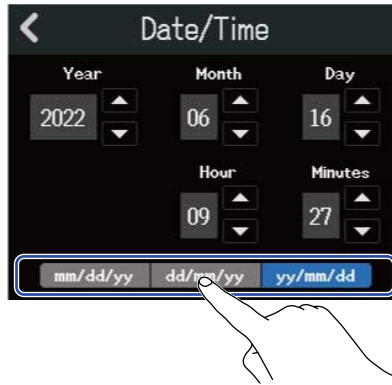

- mm/dd/yy: month/day/year
- dd/mm/yy: day/month/year
- yy/mm/dd: year/month/day

5. Tap .



This confirms the set date and time and returns to the previous screen.

NOTE:

If power is not supplied by an AC adapter for a long time, date and time settings will be reset. If the Date/Time Setting Screen appears during startup, set them again.

Setting the type of batteries used

Set the type of battery used by the R12 correctly so that the amount of remaining battery charge can be shown accurately on the screen.

1. Tap  on the Projects Screen (→ [Opening projects](#)).



2. Tap the type of batteries.





Setting	Explanation
Alkaline	Alkaline batteries
Ni-MH	Nickel-metal hydride batteries
Lithium	Lithium batteries

Adjusting the brightness of the touchscreen

The brightness of the touchscreen can be adjusted.

1. Tap  on the Projects Screen (→ [Opening projects](#)).



2. Slide the LCD Brightness slider or tap  and .

This adjusts the brightness.

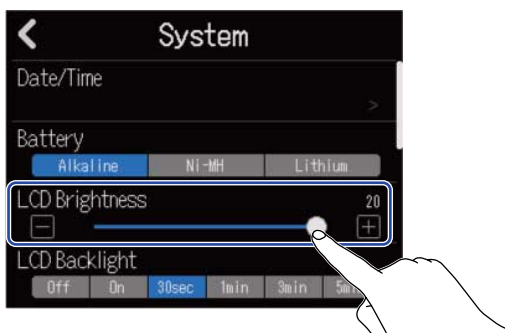

HINT:

This can be set from 1 to 20.

Setting the touchscreen backlight

The touchscreen backlight illumination can be set to conserve power.

1. Tap  on the Projects Screen (→ [Opening projects](#)).



2. Tap the desired LCD Backlight setting.

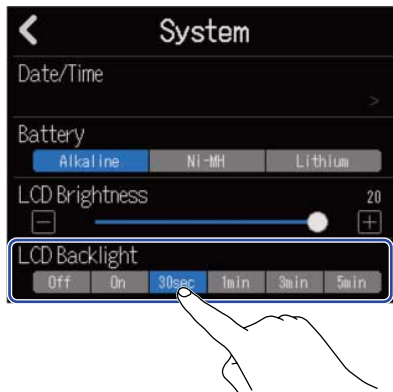

Setting	Explanation
Off	The touchscreen backlight will always stay off.
On	The touchscreen backlight will always stay on.
30sec/1min/3min/5min	The touchscreen backlight will turn off if no operation occurs for the set amount of time (30 seconds, 1 minute, 3 minutes or 5 minutes).

Managing microSD cards

Checking microSD card information

The size and open space of microSD cards can be checked.

1. Tap  on the Projects Screen (→ [Opening projects](#)).



2. Tap "SD Card".

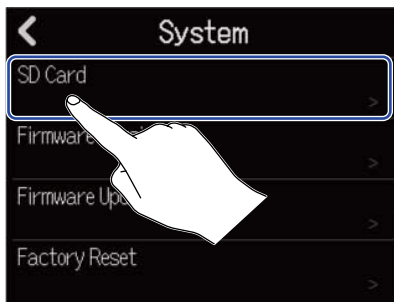

3. Check the open space and size shown by "Size".

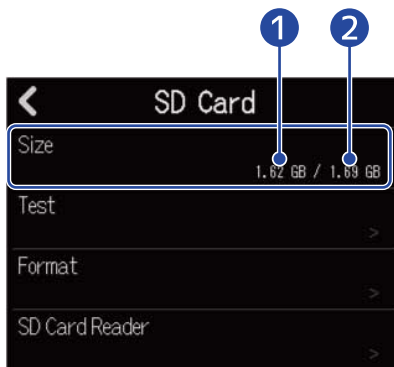

- 1 Open space
- 2 Size

Testing microSD card performance

You can test whether a microSD card can be used with the R12.

A Quick Test can be done in a short amount of time, while a Full Test examines the entire microSD card.

1. Tap  on the Projects Screen (→ [Opening projects](#)).



2. Tap "SD Card".

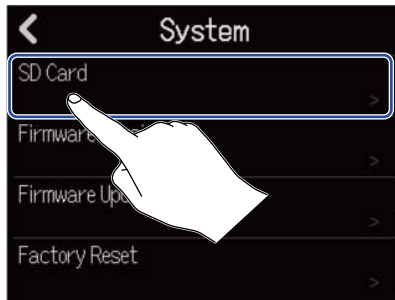

3. Tap "Test".

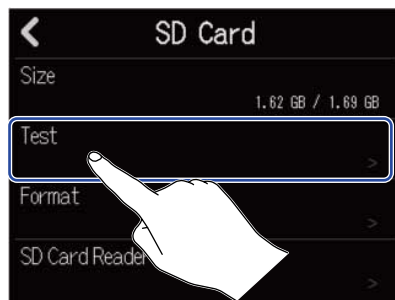

4. Tap "Quick Test" or "Full Test". Then, tap "Execute".
The card performance test will start.

Quick testing

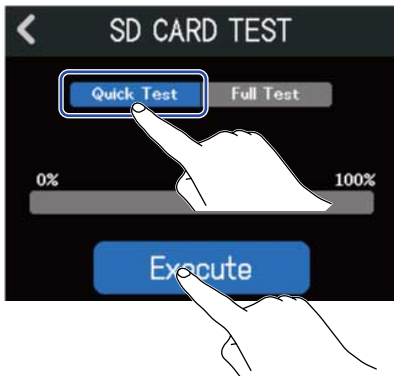

The Quick Test should take about 30 seconds.

Full testing

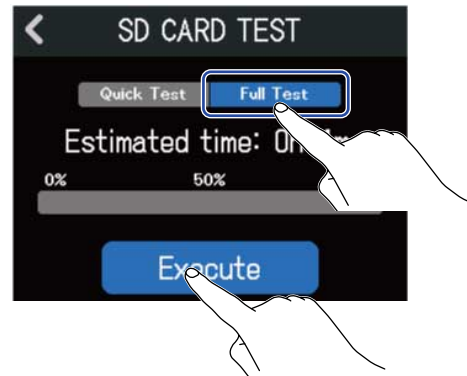

The amount of time required for the full test will be shown.

The result of the test will be shown when it completes.

During a full test, if the access rate MAX reaches 100%, the card will fail (NG).

NOTE:

Even if a performance test result is "OK", there is no guarantee that writing errors will not occur. This information is just to provide guidance.

HINT:

Tap  to cancel a test.

Formatting microSD cards

To maximize the performance of a microSD card, use the R12 to format it.

1. Tap  on the Projects Screen (→ [Opening projects](#)).



2. Tap "SD Card".

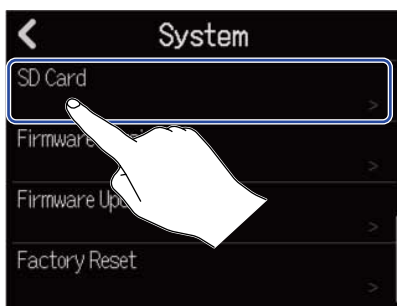

3. Tap "Format".

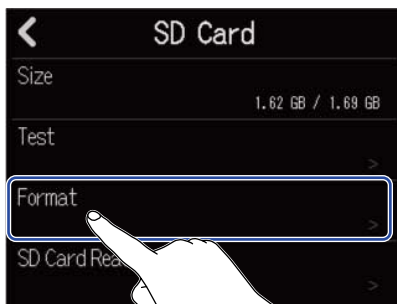

4. Tap "Execute".

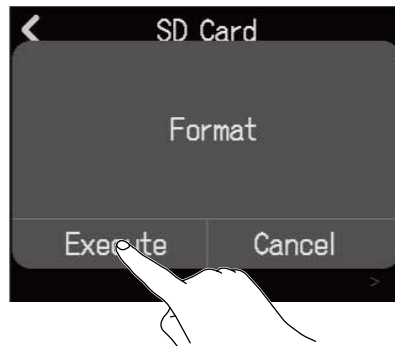

This formats the card.

Tap "Cancel" to cancel formatting.

NOTE:

- Before using microSD cards that have just been purchased or that have been formatted on a computer, they must be formatted by the R12.
- Be aware that all data previously saved on a microSD card will be deleted when it is formatted.

Using as a card reader

By connecting with a computer, data on cards can be checked and copied.

Use this to back up projects on a computer and to load audio data and MIDI files from a computer, for example.

Connecting to a computer

1. Tap  on the Projects Screen (→ [Opening projects](#)).



2. Tap "SD Card".

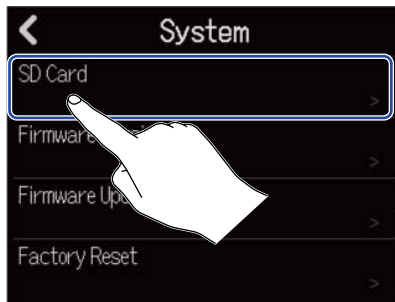

3. Tap "SD Card Reader".

This opens the SD Card Reader Screen.

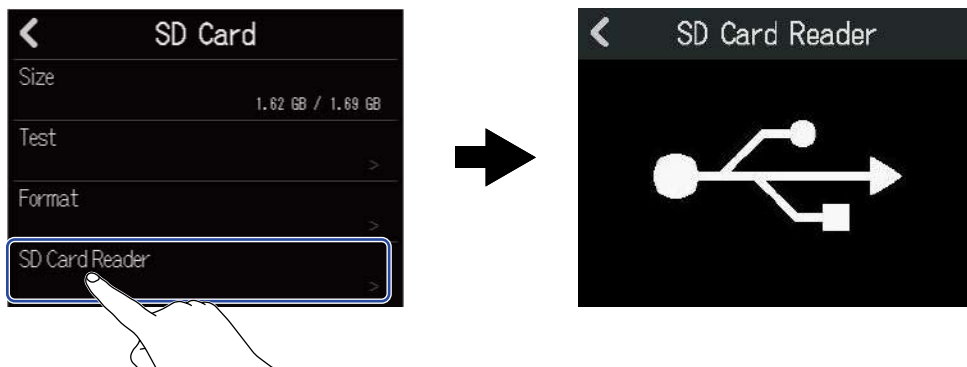

4. Use a USB (Type-C) cable to connect the R12 and the computer.

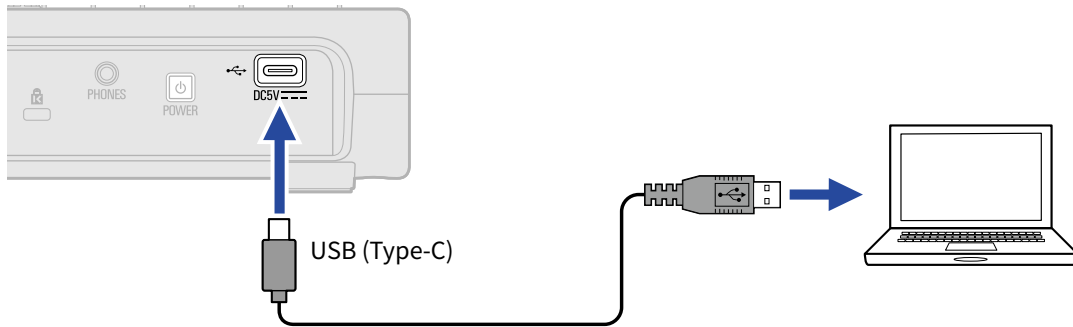

NOTE:

- Use a USB (Type-C) cable that supports data transfer.
- The R12 can be operated using USB bus power.

■ Disconnecting from the computer

1. Disconnect on the computer.

Windows:

Select the R12 with "Safely Remove Hardware".

From Mac:

Drag the R12 icon to the Trash and drop it.

NOTE:

Always conduct computer ejection procedures before disconnecting the USB cable.

2. Disconnect the USB cable connecting the R12 with the computer, and tap .

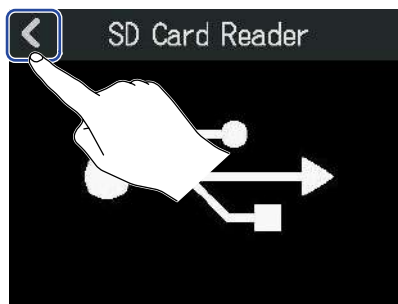

3. Tap "Execute".

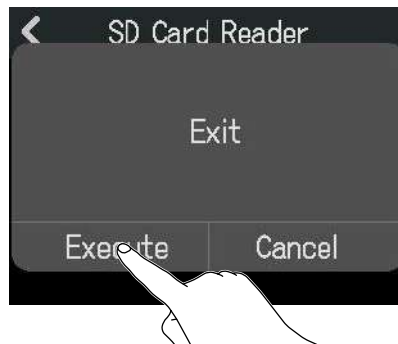

This disconnects with the computer and reopens the SD Card Screen.
Tap "Cancel" to cancel disconnecting and return to the previous screen.

Restoring default setting values

The R12 can be restored to its factory default settings.

1. Tap  on the Projects Screen (→ [Opening projects](#)).



2. Tap "Factory Reset".



3. Tap "Execute".
This executes the reset.

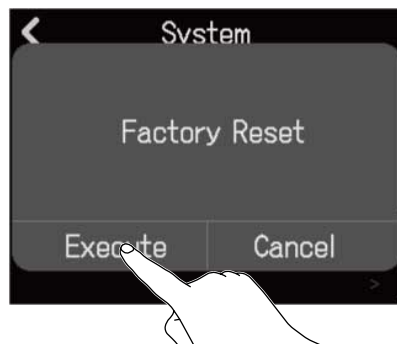

Tap "Cancel" to cancel resetting and return to the previous screen.

4. When "Done" appears, tap "Close".
The power will turn off automatically.

NOTE:

- Resetting will restore all settings to their factory defaults. Be certain before using this function.
- After resetting the R12 to its factory default state, initial settings will be necessary the next time the power is turned on. (→ [Setting the date and time \(first time starting up\)](#))

Managing the firmware

Checking the firmware versions

1. Tap  on the Projects Screen (→ [Opening projects](#)).



2. Tap "Firmware Version".

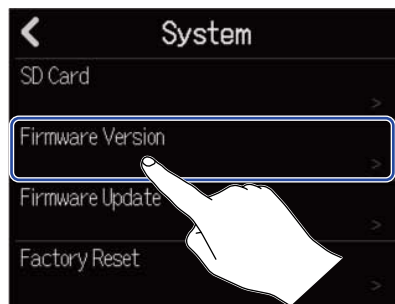

This shows the firmware and preset versions.

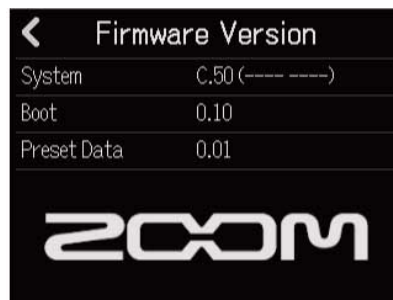

Updating

The R12 firmware can be updated to the latest versions.

The latest update file can be downloaded from the ZOOM website (zoomcorp.com). <https://zoomcorp.com>

Follow the instructions in the "R12 Firmware Update Guide" on the R12 download page.

Appendix

Troubleshooting

If you think the R12 is operating strangely, check the following items first.

Recording/playback trouble

There is no sound or output is very quiet

- Check the connections to the monitoring system and its volume setting.
- Confirm that the volume of the R12 is not too low. (→ [Playing projects](#))

Sound from connected equipment or inputs cannot be heard or is very quiet

- Check the input level settings. (→ [Adjusting input levels](#))
- If a CD player or other device is connected to an input jack, raise the output level of that device.
- Operate  knobs and faders to adjust the volume.
- Check phantom power settings. (→ [Enabling tracks for recording](#))

Recording is not possible

- Check recording track settings. (→ [Enabling tracks for recording](#))
- Confirm that the microSD card has open space. (→ [Checking microSD card information](#))
- Confirm that a microSD card is loaded properly in the card slot.
- If "SD card protected!" appears on the display, the microSD card write-protection is enabled. Slide the lock switch on the card to disable write-protection.

Recorded sound cannot be heard or is very quiet

- Confirm that the volume levels of the tracks are not too low. (→ [Playing projects](#))
- Confirm that the tracks are not muted and that other tracks are not soloed. (→ [Muting tracks](#), [Listening to selected tracks only \(soloing\)](#))

Other trouble

Computer does not recognize it even though it is connected to a USB port

- Confirm that the operating system is compatible. (→ [Using as an audio interface](#), [Using as a card reader](#))
- Connection operations must be done on the R12 to allow the computer to recognize it. (→ [Using as an audio interface](#), [Using as a card reader](#))

Block diagram

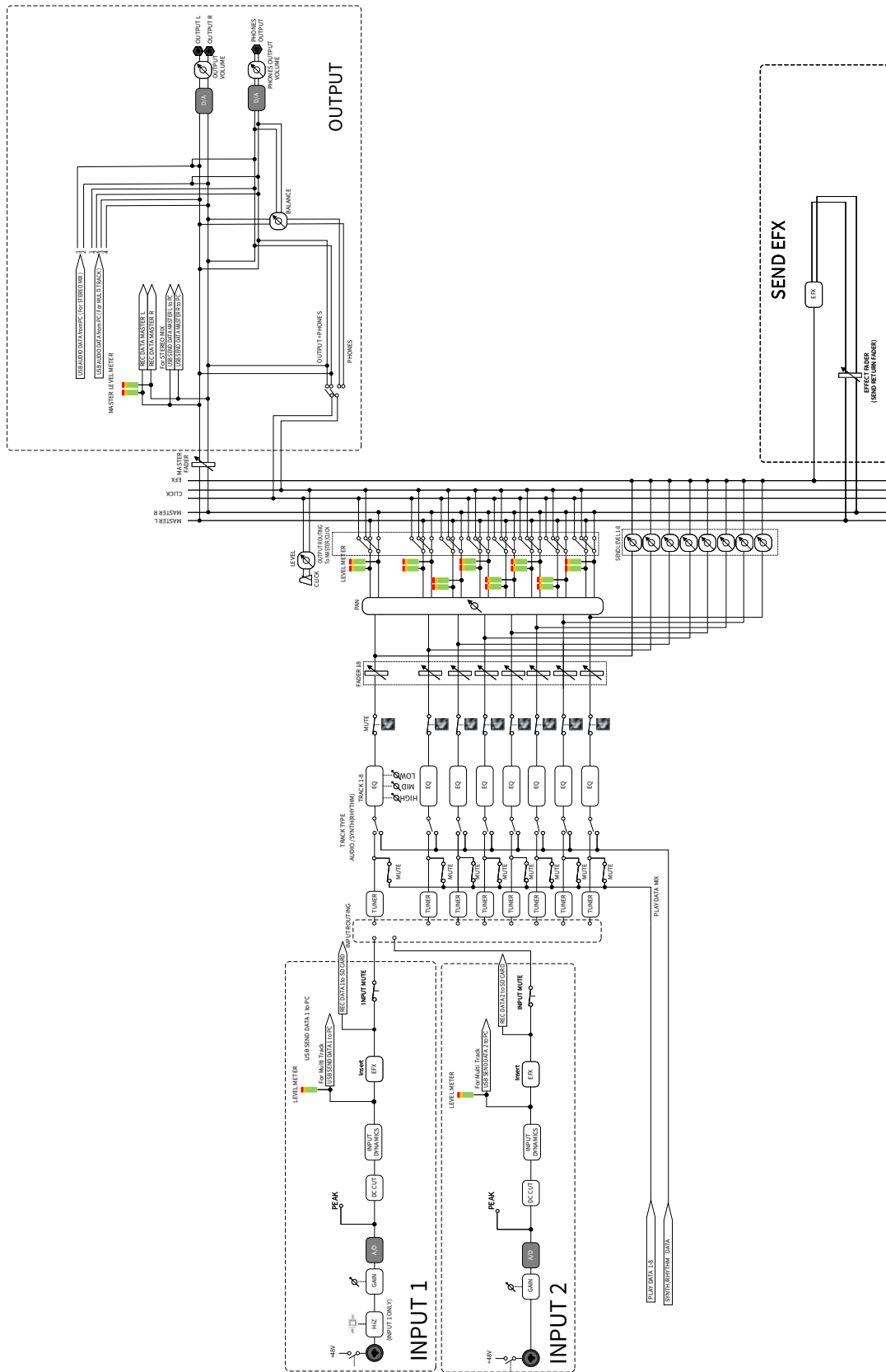

MIDI implementation chart

[MultiTrak]

Model : R12

Date : Sept. 1, 2022

Version :1.00

Function ...		Transmitted	Recognized	Remarks
Basic Channel	Default Changed	x x	1 - 16 x	
Mode	Default Messages Altered	x x *****	Mode 1 x *****	
Note Number	True voice	x *****	0 - 127 24 - 124	C0 - E8
Velocity	Note ON Note OFF	x x	o x	
After Touch	Key's Ch's	x x	x x	
Pitch Bend		x	x	
Control Change		x	x	
Program Change	True Number	x *****	x *****	
System Exclusive		x	x	
Common	Song Position Song Select Tune Request	x x x	x x x	
System Real Time	Clock Commands	x x	x x	
Aux Messages	Local ON/OFF All Notes OFF Active Sense System Reset	x x x x	x o x x	
Notes				

Mode 1 : OMNI ON, POLY
Mode 3 : OMNI OFF, POLY

Mode 2 : OMNI ON, MONO
Mode 4 : OMNI OFF, MONO

o : Yes
x : No

Specifications

Input and output channel counts	Inputs	MIC/LINE (mono)	2
	Outputs	MASTER OUT	1
		PHONES	1
Inputs	Connectors	2 XLR/TRS combo jacks (Balanced, XLR: 2 HOT / TRS: TIP HOT)	
	Input gain	+6 dB – +50 dB	
	Input impedance	XLR: 3.9 k Ω TRS: 3.9 k Ω /1 M Ω (when Hi-Z ON, INPUT 1 only)	
	Phantom power	+48 V (switchable separately for INPUTS 1 and 2)	
	Equivalent input noise	–121 dBu or less (IHF-A) at +50 dB/150 Ω input	
	Frequency response	–1.0/+0.5 dB: 20 Hz – 20 kHz	
Outputs	MASTER OUT	Connectors	2 TRS phone jacks (balanced)
		Maximum output level	+14 dBu
		Output impedance	200 Ω
	PHONES	Connectors	1 stereo 3.5mm mini jack
		Maximum output level	45 mW + 45 mW (into 32 Ω load)
		Output impedance	10 Ω
Recorder	Maximum simultaneous recording tracks	2	
	Maximum simultaneous playback tracks	8	
	Recording format	44.1 kHz, 16/24-bit, mono/stereo WAV	
	Recording media	Cards compatible with microSDHC specifications 4 GB – 32 GB Cards compatible with microSDXC specifications 64 GB – 1 TB	
Track settings	EQ	High: 10 kHz, \pm 12 dB, shelving Middle: 2.5 kHz, \pm 12 dB, peaking Low: 100 Hz, \pm 12 dB, shelving	
	Pan	L100 – R100	
Effects	Input Dynamics	Comp/Limiter/Gate	

	Patch memory effects	3 types can be used simultaneously 50 patch memories Guitar Lab supported Can be assigned and used as an insert (input) or send effect	
	Dedicated send effects	10 types of spatial effects	
Tuner		Chromatic/Guitar/Bass/Open A/Open D/Open E/Open G/DADGAD	
Click (metronome)	Time signatures	3/4, 4/4, 6/8	
	Tempo range	40.0 – 250.0 BPM	
Rhythm loops	Sound source format	PCM	
	Number of loops	150	
Synth	Sound source format	FM	
	Polyphony	8	
	Number of sound types	18 (and a PCM drum kit)	
Display		2.4" (320×240) full-color touchscreen LCD	
USB	Connector	USB Type-C Note: Use a USB cable that supports data transfer. USB bus power is supported.	
	Audio interface function	2-in/2-out or 2-in/2-out (iPad)	USB 2.0 Full Speed 44.1 kHz, 16/24-bit
		2-in/4-out	USB 2.0 High Speed 44.1 kHz, 16/24-bit
	Mass storage function	Device	USB 2.0 High Speed (5 V/200 mA power supplied when host)
	Guitar Lab connection		USB 1.1 Full Speed
	DAW connection (control surface)		USB 1.1 Full Speed
	Mass storage function	Host	USB 2.0 High Speed (5V/200 mA power supplied)
	USB MIDI keyboard connection		USB 1.1 Full Speed (5 V/200 mA power supplied)
Power		Batteries: 4 AA (alkaline, lithium, or rechargeable NiMH) AC adapter: ZOOM AD-17 (5V/1.0A) • USB bus power is supported.	

Estimated continuous operation time using batteries	During playback with +48V off and 32Ω headphone load	Alkaline batteries: about 5 hours NiMH batteries (1900 mAh): about 5 hours Lithium batteries: about 11 hours • The above values are approximate. • Continuous battery operation times were determined using in-house testing methods. They will vary greatly according to use conditions.
Power consumption		5 W maximum
Dimensions		256 mm (W) × 158 mm (D) × 61 mm (H)
Weight (including batteries)		827 g

Note: 0 dBu = 0.775 Vrms



ZOOM CORPORATION

4-4-3 Kanda-surugadai, Chiyoda-ku, Tokyo 101-0062 Japan

zoomcorp.com